

产品选型手册
Product Selection Guide

Keep Think

KEEP THINK

让世界冷冻冷藏行业爱上中国智造

Let the world's refrigeration industry fall in love with China's intelligent manufacturing

企业使命 Mission 让舒适生活可以时刻感受到温度魅力
To make the charm of temperature control part of every moment of comfortable living.

企业愿景 Vision 成为冷冻冷藏行业控制器领域的技术引领者
To lead innovation in refrigeration and control technologies.

企业价值观 Values 用思考促进行业，用创新构造产品，用行动改变命运
**Drive the industry through thinking,
build products through innovation,
and change destinies through action.**

Keep Think

重要警告 Important warning:

凯普信产品开发基于25年冷冻冷藏电子控制器的技术经验积累，以及产品硬件、软件、严格的制造流程控制三方面的紧密结合，并采用了市场上最新的设计风格。

尽管本公司产品是基于最先进技术开发的，但凯普信公司仍无法确保产品的各个方面能够满足最终所有用户应用的要求。

为达到特定的最终设备的预期效果，客户可以对本产品进行设置，但与此相关的所有责任和风险由客户承担。

凯普信公司可为最终系统带负荷试运行提供技术顾问服务，但是不负责最终设备的正确运行。

每个凯普信产品都拥有先进的技术，都需要进行安装、设置、调试，从而能在特定应用中以最佳方式运行。

如未按产品要求操作，可能会导致最终产品出现故障，此种情况下，凯普信不承担任何责任。

KeepThink's product development is based on 25 years of technical experience in refrigeration and refrigeration electronic controllers.

Close integration loop of product hardware, software, and strict manufacturing process control, Adopted the latest design style on the market.

Although the company's products are developed based on the most advanced technology, KeepThink still cannot ensure that all aspects of the product can meet the requirements of all end users.

In order to achieve the desired effect of the specific final equipment, the customer can set this product, but all the responsibilities and risks related to this are borne by the customer. KeepThink can provide technical consulting services for the load trial operation of the final system, but is not responsible for the correct operation of the final equipment. Each KeepThink product has advanced technology and needs to be installed, set up, and debugged in order to operate in the best way in a specific application.

Failure to operate according to product requirements may result in failure of the final product. In this case, KeepThink does not assume any responsibility.

使用凯普信产品还必须重视适用于所有电子产品的以下警告：

The use of KeepThink products must strictly follow warnings applicable to all electronic products:

◇雨水、湿气以及各种冷凝液体可能含有腐蚀性物质并损坏电子电路。

Rain water, humidity and various condensate liquid may contain corrosive substances and damage electronic circuits.

◇环境高温会缩短电子产品的使用寿命，并使塑料部件变形或熔化。

High ambient temperature will shorten the service life of electronic products and cause plastic parts to deform or melt.

◇不论何种情况下，用户均需保证产品工作电压和所接负载额定电流、峰值电流均不超过产品技术描述。

In any case, the user must ensure that the working voltage of the product and the rated current and peak current of the connected load do not exceed the technical description of the product.

◇任何被拆卸、改动后的产品，凯普信均不予提供服务和质量保证。

KeepThink will not provide service and quality assurance for any product that has been disassembled or modified.

◇发生坠落、撞击会导致产品内部继电器簧片变形，严禁安装使用。

Falling or impact will cause the internal relay reed to deform, so in case of disformation, installation is strictly prohibited.

◇不得使用腐蚀性化学品、溶剂清洁设备。Do not use corrosive chemicals or solvents to clean the equipment.

◇未经允许不得将公司产品用于航空航天、军事、生命保障支持设备。

Do not use our products in aerospace, military, life support equipment without permission.

目录 Contents

A	通用控制器 Universal Controller
B	展示柜控制器 Display Cabinet Controller
C	冷藏车控制器 Refrigerated Vehicle Controller
D	厨房冰箱控制器 Kitchen Refrigerator Controller
E	冷库控制器 Cold Storage Controller
F	特殊控制器 Special Controller
G	洗碗机控制器 Dishwasher Controller
H	嵌入式显示器 LED Panel Display
I	配件 Parts
J	接线图详情列表 List of Detailed Wiring Diagrams

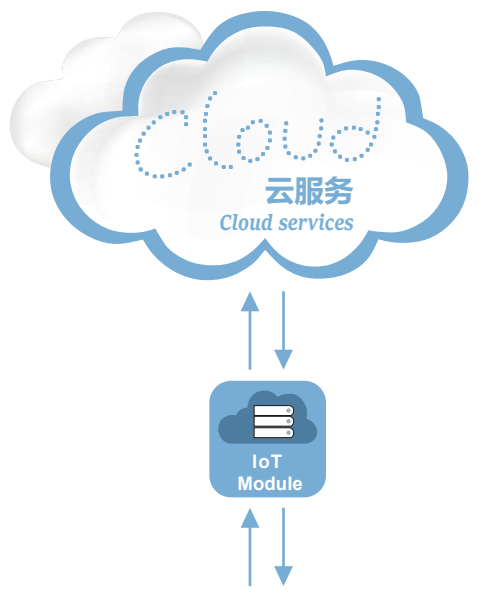

Using Technology Change Future, Make The Controller **SoEasy**.
 用科技改变未来，让制冷如此简单。

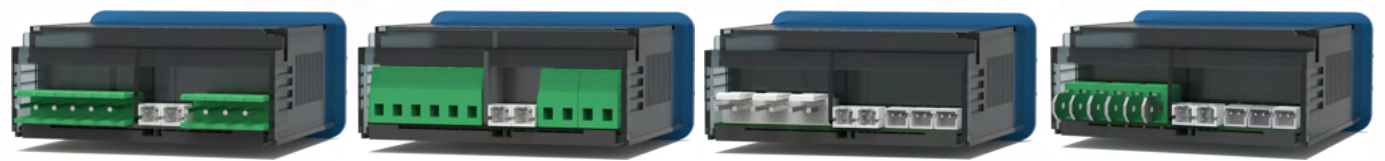

KeepThink —— 创新，源于持续的思考和行动

通用型控制器系列 - SoEasy系列

General Controller Series-SoEasy Series

用科技改变未来，让制冷如此简单

Using Technology Change Future, Make The Controller SoEasy.



外观极简设计 Minimalist appearance design

- ◆ 无边框全面屏设计，极致放大的数字显示区。Frameless full-screen design, extremely enlarged digital display area.
- ◆ 更小的安装深度，便于用户在紧凑空间内的安装使用。The smaller installation depth, convenient for users to install and use in a compact space.

选型简单、通用性强 Simple selection and strong versatility

- ◆ 强大且灵活的全面模块化固件设计，用户根据制冷系统自由选型。
Powerful and flexible comprehensive modular firmware hardware design, wide choices for users according to the refrigeration system.
- ◆ 华氏/摄氏自由转换，0.1°C/°F显示和调整分辨率，控温更精确。
Fahrenheit/Celsius easy conversion, 0.1°C/°F display and adjustment resolution, more accurate temperature control.
- ◆ 两级ECO-door模式可让制冷设备尽可能的降低能耗开销。
The two-stage ECO-door mode allows refrigeration equipment to reduce energy consumption as much as possible.
- ◆ 具有软件开关机记忆功能，可随时自由开启/关闭制冷系统的运行。
It has a software switch memory function, which can freely turn on/off the operation of the refrigeration system at any time.
- ◆ 全系列支持扩展分体显示器，生产者、消费者都可以轻松看到制冷设备运行温度。The whole series supports extended split display, so both producers and consumers can easily see the operating temperature of refrigeration equipment.
- ◆ 热气除霜模式时支持排水管提前启动加热，防止冰堵。
In hot gas defrost mode, the drain pipe can be heated in advance to prevent ice blockage.
- ◆ 精确的风机控制，有利于保证制冷设备内温度场均匀性，并有效减少电能浪费。Precise fan control ensures the uniformity of the temperature field in the refrigeration equipment and effectively reduce the waste of electricity.
- ◆ 功能全面、多场景适用，冷库、运输、医院、酒店、机场、商场、超市、蛋糕房等，满足各类制冷控制系统需求。
Comprehensive functions, applicable to multiple scenarios, cold storage, transportation, hospitals, hotels, airports, shopping malls, supermarkets, bakeries, etc., for the needs of various refrigeration control systems.

安装简洁、灵活 Simple and flexible installation

- ◆ 参数调整更简单快捷：可快速还原出厂参数或使用DLOAD配件快速设置专属出厂参数。Simpler and faster parameter adjustment, you can quickly restore the factory parameters or use DLOAD accessories to quickly set the exclusive factory parameters.
- ◆ DLOAD可快速上传、下载参数，并具有上传防错锁定开关，小巧设计，携带方便，即插即用。
DLOAD can upload and download parameters quickly, and has an upload error-proof locking switch, compact design, easy to carry, plug and play.
- ◆ DataLink可灵活组建、扩充形成485通信网络；DataLink can be flexibly formed and expanded to form a 485 communication network;
- ◆ 欧规螺钉端子、欧规螺钉插接端子、旗形插片端子、条形插接端子，四种连接方式均可支持。
European standard screw terminals, European standard screw plug-in terminals, flag-shaped blade terminals, strip-shaped plug-in terminals, four connection methods can be supported.

更高品质，客户使用更安心 Higher quality, more peace of mind for customers

- ◆ 高阻燃、高灼热丝、全透明PC材质壳体，让一切品质都要在阳光下看得见。
High flame-retardant, high glow wire, fully transparent PC material shell, all the quality can be seen apparently.
- ◆ 匠心独具的防护设计可提供业界同类产品最佳保护能力，结合WPX配件，可确保在高温、高湿、脏污环境中长期安全使用；
The ingenious protection design can provide the best protection of similar products in the industry, Combined with WPX accessories, it can ensure long-term safe use in high temperature, high humidity, and dirty environments;
- ◆ 内外分离、强弱电分隔的特殊结构设计可提供更高的使用安全性。
The special structure design with internal and external separation and strong and weak electrical separation can provide higher safety in use.

SoEasy系列通用型控制器命名 SoEasy series generic controller naming

命名解释 Model	产品前缀 Prefix	基本特征 Essential feature
A系列基础款 A Series(Basic)	AB2300	通用型控制器 General purpose controller
A系列节能款 A Series(ECO)	AB3300	
A系列通信款 A Series(Network)	ABU3300	具有通信功能的通用控制器 General purpose controller with communication function
A系列LED输出款 A Series (LED)	ABL2300	可直接驱动12V*1A的灯光负载 The controller can directly drive 12V*1A light load
	ABL3300	
A系列医疗款 A Series(Medical)	AMU3300	医疗控制器 Temperature lower than -100°C
A系列速冻款 A Series(Quick-freezing)	ADC4300	具有速冻模式的温度控制器 Quick-freezing controller
A系列兼容款 A Series(Compatible)	AC10XX	兼容型产品 Compatible product
	AC29XX	
	AC39XX	
	AC4020	
A系列湿控款 A Series (Humidity)	AH100	湿度控制器 Humidity controller
A系列恒温款 A Series (CT)	AX20	恒温控制器 Constant temperature controller
A系列分体款 A Series (Split)	ASKN100U	分体式控制器 Split type controller
	ASKN100R	

SoEasy系列控制器基本技术规格 Basic technical specifications of SoEasy series controllers

工作电源Power supply 7~60VDC;最低电压7VDC,最高60VDC;自动稳压 12VDC;Vin(min)=7VDC,Vin(max)=60VDC,Vout=12VDC 220~240VAC, 短时最大过载电压 Short time max overload voltage <264VAC/15min; 100~127VAC, 短时最大过载电压 Short time max overload voltage <144VAC/15min;	整机功耗 Overall power consumption : <3W
继电器输出Relay output 制冷: 常开输出, 建议压缩机额定电流FLA≤8A,堵转电流LRA≤72A; 除霜: 常开输出, 建议加热丝最大电流不超过6A; 风机: 常开输出, 建议风机最大电流不超过3A; 灯光: 常开输出, 建议灯光最大电流不超过1A,最大瞬态电流不超过10A;	Refrigeration : N.O. FLA≤8A ; LRA≤72A ; Defrosting : N.O. Rated current≤6A ; Fan : N.O. Rated current≤3A ; Light : N.O. Rated current≤1A , Peak current≤10A ;
安装尺寸Mounting dimension(mm): 71×29	
产品尺寸Product dimensions(mm): 76.5×35 ,深度Depth = 60(T)/65(V)/65(R)/70(F)	
控制器安装方式: 嵌入式设备, 配套弹性卡, 后部固定 Installation method of controller: Embedded device, matching elastic card, rear fixed	
接线方式Connection mode:	
螺钉端子Screw terminal (T)	条形插拔端子Bar connector (V)
螺钉插拔端子Plug terminal (R)	插片端子Tab terminals (F)
导线Wire (W)	
工作环境温度Operating ambient temperature : -10~55°C	存储温度Storage temperature : -25~75°C
相对湿度: 0%~90% (无结露) Relative humidity : 0%~90% (no condensation)	
前面板保护等级IP65, 具有防漏水保护结构 Front panel protection level IP65, with anti-flood water protection structure	
人工操作界面: 4按键/6按键 Manual operation interface : 4 keys /6 keys	

SoEasy系列控制器主要功能特点 Main functions and features of SoEasy series controllers

测量温度LED数字显示 工作状态LED符号显示 Measuring temperature LED digital display , working state LED symbol display
可外接扩展显示器P-850/950/1050实时同步显示库温 The external panel table P-850/950/1050 can synchronously display the cabinet temperature in real time
°C/°F 转换 Conversion
TTL通讯, 可与配件DataLink组建485通信网络 TTL , can set up 485 communication network with accessory DataLink
最多三路温度采集 (NTC) : 库温、蒸发器温度、蒸发器温度2、冷凝器温度 Maximum three channel temperature acquisition (NTC) : storage temp, evaporator temp, evaporator temp 2, condenser temp
一路数字信号采集: 门开关、外部报警、压力异常信号检测; 启动除霜、速冷模式; 启动或退出节能模式、AUX输出; 控制开机或待机 Digital signal acquisition: door switch, external alarm, abnormal pressure signal detection; defrosting start , quick cooling mode ; Start or exit the energy-saving mode , AUX output; Control startup or standby
多种报警功能 Multiple alarm functions
制冷、制热功能 一具有节能模式、速冻模式 Refrigeration and heating functions — Energy-saving mode, quick-freezing mode
除霜 Defrost — 自然除霜、电加热除霜、热气除霜 — 可数字信号启动、手动启动、周期启动、上电启动 — Natural defrosting, electric heating defrosting, hot air defrosting — Digital signal start, manual start, cycle start, power on start
风机Fan — 多种运行方式、保证制冷同时有效节能 Avariety of operating mode to ensure refrigeration and effective energy saving
灯光 The light
报警 Alarm (可以连接外部报警警铃 External alarm bell can be connected)
AUX (辅助输出 Auxiliary output)
待机 Standby (开机即输出 Power on and output)
菜单分普通用户菜单、管理者菜单, 管理者菜单密码保护、库温设置锁定 The menu can be divided into regular user menu, manager menu, manager menu password protection with and lock of library and temperature setting
参数快速设置: 按键还原出厂参数或使用配件DLOAD 上传下载参数 Quick setting of parameters: Restore factory parameters by button or upload and download parameters using DLOAD accessories
待机/关机状态切换 Standby/shutdown status switch



接线方式Connection mode (T)
螺钉端子 Screw terminal



接线方式Connection mode (V)
条形插拔端子 Bar connector



接线方式Connection mode (R)
螺钉插拔端子Plug terminal



接线方式Connection mode (F)
插片端子Tab Terminals

AB系列-通用基础控制器

AB series - General-purpose base controller

AB2300



产品型号信息 Model Info

产品系列 Model	软件型号 Software	压机继电器 Comp. relay	端子型号 Terminal	电网电压 Supply	主板型号 Mainboard	继电器 Relay			蜂鸣音 Buzzer	显示表 Panel	内部标识 Mark	传感器 Sensor			塑料壳 Plastic shell	防爆 Explosion-proof	
						R1	R2	R3				S1	S2	S3			
AB2300	null N1...N99	H=2HP M=1HP L<=10A res.	T=Screw terminal V=NV Bar connect R=Plug terminal F=Tab terminal	null=AC220...240 A=AC100...127 W=AC100~240 D=DC8...60	10=AB-P10 20=AB-P20 23=AB-P23 31=AB-P31 35=AB-P35 37=AB-P37 44=AB-P44 ...	COMP.	DEF	FAN	P23/35: Z=R1Z P37: Z=R2Z P44: Z=R1Z	B	P	E	RT	ET	DT	BK=Black shell BU=Blue shell BK1-BK99 BU1-BU99	EX

例: AB2300-MT31-R123E-S123-BK-EX, M=1HP COMPRESSOR, T=Screw terminal, 31=PCB model, R1=compressor relay, R2=defrost relay, R3=fan relay, E=chip model, S1=room probe, S2=defrost probe, S3=Dig probe, BK=Black shell, EX=explosion-proof.

注: 上表仅为典型硬件配置, 如需了解详细情况, 请与我司联系。 Note: The table only lists the typical hardware configuration. For more details, please contact us.

技术参数 Technical Parameters

额定电压: 220~240VAC, 短时最大过载电压<264VAC/15min;

额定电压: 100~127VAC, 短时最大过载电压<144VAC/15min

Rated voltage: 220~240VAC, Maximum overload voltage<264VAC/15min;

Rated voltage: 100~127VAC, Maximum overload voltage<144VAC/15min

整机功耗Consumption: ≤3W

测量范围Display range: -50°C~99.9°C/199°F

控温范围Control range: -50°C~99.9°C/°F

测温精度Accuracy: -40~70°C, ≤±1°C; others, ≤±2°C

分辨率Resolution: -50~99.9°C/°F, 0.1; others, 1

产品尺寸Dimensions(mm): 76.5×35, 深度Depth = 60或61或44

安装尺寸Mounting(mm): 71×29

接线图 Wiring diagrams

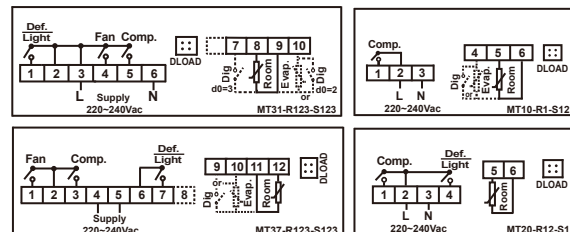

注: 更多接线图请翻阅详情表格。

Note: Please refer to the detailed table for more wiring diagrams.

参数表 Menu Parameters For Other version, please contact us.

Menu	Description	Setting Range	Unit
User Menu			
St	Temperature set point	C4...C5	°C/°F
Management Menu			
PA	Management password	0...99, master key=55	/
C1	Differential	0.1...50.0	°C/°F
C2	Compressor start minimum interval	0...99	min
C3	Room probe calibration	-20.0...20.0	°C/°F
C4	Minimum SetPoint	-50.0...St	°C/°F
C5	Maximum SetPoint	St...99.9	°C/°F
C6	Compressor initial start minimum	0...999	Sec
d0	Auxiliary probe selection	0=disable; 1=defrost; 2=digital; *3=individual defrost+digital input	/
d2	Defrost cycle	0...99, 0=Defrost forbidden	hr
d3	Maximum defrosting time	1...99	min
d4	Display lock during defrost	0= room temperature; 1=dEF;	/
d5	Room temperature display delay after	0...99	min
d7	defrost probe calibration	-20.0...20.0	°C/°F
d8	Defrost stop temperature	-50.0...99.9	°C/°F
d9	Dripping time after defrost	1...999	sec
F1	Fan running mode	0=same with the compressor, OFF during defrost; 1=continuous mode, OFF during defrost; 2=same with the compressor, ON during defrost; 3=continuous mode	/
F2	Fan start delay after defrost	0...99	min

F3	Fan stop temperature	-50.0...99.9	°C/°F
F4	Fan activation differential	0.1...50.0	°C/°F
F5	Fan proportional on time if cool off	0...250, 0=cancel proportional time	sec
F6	Fan proportional off time if cool off	1...999	min
L1	Digital signal polarity	1=close valid; 2=open valid	/
L3	Digital signal valid, Fan output	0=off; 1=no effect;	/
L6	Digital signal valid, cooling stop delay	0...999, 0=disable off cooling	min
A1	Cooling proportional off time if probe fails	0...99	min
A2	Cooling proportional on time if probe fails	0...99, 0=continuously off	min
A3	Temperature alarm delay	0...999	min
A4	Temperature alarm delay at power-on	0...999	min
A5	Temperature alarm delay after defrost	0...999	min
A6	Temperature alarm upper differential	0.1...50.0	°C/°F
A7	Temperature alarm lower differential	0.1...50.0	°C/°F
A8	Alarm exit differential	0.1...20.0	°C/°F
A9	Display delay of 1°C/°F increasing	0...999	sec
LC	Room temperature set point lock	0=lock; 1=unlock	/
P1	Set manager menu password	0...99, 0=not password	/
P3	Auxiliary output function selection	0=defrost; 1=light, set to 1 only natural defrost	/
P4	Cooling and heating options.	0=cooling+electric defrost; 1=heating+electric defrost; *2=cooling+hot gas defrost	/
P9	°C/°F selection	0=°F; 1=°C	/

AB系列-通用节能控制器

AB series - General energy-saving controller

AB3300



产品型号信息 Model Info

产品系列 Model	软件型号 Software	压机继电器 Comp. relay	端子型号 Terminal	电网电压 Supply	主板型号 Mainboard	继电器 Relay				蜂鸣音 Buzzer	显示表 Panel	内部标识 Mark	传感器 Sensor			塑料壳 Plastic shell	防爆 Explosion-proof	
						R1	R2	R3	R4				S1	S2	S3			
AB3300	null N1...N99	H=2HP M=1HP L<=10A res.	T=Screw terminal V=NV Bar connect R=Plug terminal F=Tab terminal	null=AC220...240 A=AC100...127 W=AC100~240 D=DC8...60	31=AB-P31 35=AB-P35 37=AB-P37 41=AB-P41 44=AB-P44	COMP.	DEF	FAN	LIGHT	P35/44: Z=R1Z P37: Z=R2Z	B	P	E	RT	ET	DT	BK=Black shell BU=Blue shell BK1~BK99 BU1~BU99	EX

例: AB3300-MT31-R123-S123-BK-EX, M=1HP COMPRESSOR, T=Screw terminal, 31=PCB model, R1=compressor relay, R2=defrost relay, R3=fan relay, S1=room probe, S2=defrost probe, S3=Dig probe, BK=Black shell, EX=explosion-proof.
注: 上表仅为典型硬件配置, 如需了解详细情况, 请与我司联系. Note: The table only lists the typical hardware configuration. For more details, please contact us.

技术参数 Technical Parameters

额定电压: 220~240VAC, 短时最大过载电压 <264VAC/15min;
 额定电压: 100~127VAC, 短时最大过载电压 <144VAC/15min
 Rated voltage: 220~240VAC, Maximum overload voltage <264VAC/15min;
 Rated voltage: 100~127VAC, Maximum overload voltage <144VAC/15min
 整机功耗Consumption: ≤3W
 测量范围Display range: -50°C~99.9°C/199°F
 控温范围Control range: -50°C~99.9°C/°F
 测温精度Accuracy: -40~70°C, ≤±1°C; others, ≤±2°C
 分辨率Resolution: -50~99.9°C/°F, 0.1; others, 1
 产品尺寸Dimensions(mm): 76.5×35, 深度Depth = 60或61
 安装尺寸Mounting(mm): 71×29

接线图 Wiring diagrams

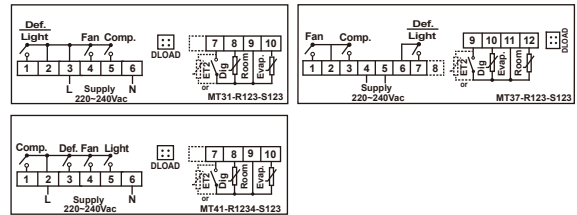

注: 更多接线图请翻阅详情表格.
Note: Please refer to the detailed table for more wiring diagrams.

参数表 Menu Parameters For Other version, please contact us.

Description	Range	Unit
User Menu		
St Temperature SetPoint	C4...C5	°C/°F
Management Menu		
PA Manager menu password	0...99, master key=55	/
C1 Differential	0.1...50.0	°C/°F
C2 Compressor start minimum interval	0...99	min
C3 Room probe calibration	-20.0...20.0	°C/°F
C4 Minimum SetPoint	-50.0...St	°C/°F
C5 Maximum SetPoint	St...99.9	°C/°F
C6 Compressor initial start minimum interval	0...999	sec
d1 defrost probe selection	0=disable; 1=enable; 2=enable double defrost probe	/
d2 Defrost cycle	0...99, 0=Defrost forbidden	hr
d3 Maximum defrosting time	1...99	min
d4 Display lock during defrost	0= room temperature; 1=dEF; 2=Room temperature when defrosts starts,	/
d5 Room temperature display delay after defrost	0...99	min
d6 First defrosting interval after power on	10...999	min
d7 Defrost probe calibration	-20.0...20.0	°C/°F
d8 Defrost stop temperature	-50.0...99.9	°C/°F
d9 Dripping time after defrost	0...999	sec
d10 Defrost type	0=Electric; 1= Hot gas	/
d11 Defrost cycle calculation	0: cooling time; 1: natural time	/
d12 Defrost start output delay	0...999, 0=cancel defrost delay	sec
d13 Defrost at power-on	0=off; 1=on;	/
F1 Fan running mode	0=same with the compressor, OFF during	/
F2 Fan start delay after defrost	0...99	min
F3 Fan stop temperature	-50.0...99.9	°C/°F
F4 Fan activation differential	0.1...50.0	°C/°F
F5 Fan proportional on time if cool off	0...250, 0=off proportional running	sec
F6 Fan proportional off time if cool off	1...999	min
A1 Cooling proportional off time if probe fails	0...99	min
A2 Cooling proportional on time if probe fails	0...99, 0=continuously off	min
A3 Temperature alarm delay	0...999, 999=disable	min
A4 Temperature alarm delay at power-on	0...999	min
A5 Temperature alarm delay after defrost	0...999	min
A6 Temperature alarm upper differential	0.1...50.0	°C/°F
A7 Temperature alarm lower differential	0.1...50.0	°C/°F
A8 Alarm exit differential	0.1...20.0	°C/°F
A9 Display delay of 1°C/°F increasing	0...999	sec
L1 Digital input polarity	0=disable and; 1=close valid; 2=open valid	/
L2 Digital signal valid, sound alarm output	0=off; 1=on	/
L3 Digital signal valid, Fan output	0=off; 1=not effect	/
L4 Digital signal valid, sound alarm delay	0...999	sec
L5 Restart delay after door open and fan off	0...199	sec
L6 Digital signal valid, cooling stop delay	0...999, 0=disable off cooling	min
L7 deep cool mode start deviation(not with ECO)	0.1...40.0	°C/°F
L8 deep cool mode stop deviation(not with ECO)	0.1...20.0	°C/°F
L9 deep cool mode start detection time	0...999, 0=disable deep cool mode	min
L10 deep cool mode maximum working time	0.1...99.9	hr
L11 Door action count for start defrost	0...199, 0=disable start defrost	/
L12 Minimum cycle for door action to start defrost	1...999	min
L13 deep cool mode cycling continuous time	0...999	min
EC1 Enable ECO-DOOR mode	0=no; 1=yes	/
EC2 Time to activate ECO mode	1...500	min
EC3 Temperature differential of ECO mode	0.1...20.0	°C/°F
EC4 Time to activate Store Closing Mode	1...500	min
EC5 Temperature differential in store close mode	0.1...20.0	°C/°F
EC6 Number of actions to exit ECO mode	1...15	/
LC Room temperature set point lock	0=lock; 1=unlock	/
P1 Set manager menu password	0...99, 0=not password	/
P5 Second relay function set	0=Light, Light is related to keys 1=Defrost, Light is related to keys 2=Light, Light is related to digital signal; 3=Defrost, Light is related to digital signal;	/
P9 °C/°F selection	0=°F; 1=°C	/
AdU Upload data interval (ABU series valid)	0...120, 0=disable	sec
Adr Controller address (ABU series valid)	1...255	/

通用联网控制器

General network controller

ABU3300/AC2974N1



产品型号信息 Model Info

产品系列 Model	软件型号 Software	压机继电器 Comp. relay	端子型号 Terminal	电网电压 Supply	主板型号 Mainboard	继电器 Relay					蜂鸣音 Buzzer	显示表 Panel	内部标识 Mark	传感器 Sensor			塑料壳 Plastic shell	防爆 Explosion-proof
						R1	R2	R3	R4	SPDT				S1	S2	S3		
ABU3300 AC2974	null N1...N99	H=2HP M=1HP L<=10A res.	T=Screw terminal V=NV Bar connect R=Plug terminal F=Tab terminal	null=AC220...240 A=AC100...127 W=AC100~240 D=DC8...60	31=AB-P31 35=AB-P35 37=AB-P37 41=AB-P41 44=AB-P44 ...	COMP.	DEF	FAN	LIGHT	P35/44: Z=R1Z P37: Z=R2Z	B	P	E	RT	ET	DT	BK=Black shell BU=Blue shell BK1~BK99 BU1~BU99	EX

例: ABU3300-MT31-R123-S123-BK-EX, M=1HP COMPRESSOR, T=Screw terminal, 31=PCB model, R1=compressor relay, R2=defrost relay, R3=fan relay, S1=room probe, S2=defrost probe, S3=Dig probe, BK=Black shell, EX=explosion-proof.

注: 上表仅为典型硬件配置, 如需了解详细情况, 请与我司联系。Note: The table only lists the typical hardware configuration. For more details, please contact us.

技术参数 Technical Parameters

额定电压: 220~240VAC, 短时最大过载电压 <264VAC/15min;
 额定电压: 100~127VAC, 短时最大过载电压 <144VAC/15min
 Rated voltage: 220~240VAC, Maximum overload voltage <264VAC/15min;
 Rated voltage: 100~127VAC, Maximum overload voltage <144VAC/15min
 整机功耗 Consumption: ≤3W
 测量范围 Display range: -50℃~99.9℃/199°F
 控温范围 Control range: -50℃~99.9℃/F
 测温精度 Accuracy: -40~70℃, ±1℃; others, ±2℃
 分辨率 Resolution: -50~99.9℃/F, 0.1; others, 1
 产品尺寸 Dimensions(mm): 76.5×35, 深度 Depth = 60或61
 安装尺寸 Mounting(mm): 71×29

接线图 Wiring diagrams

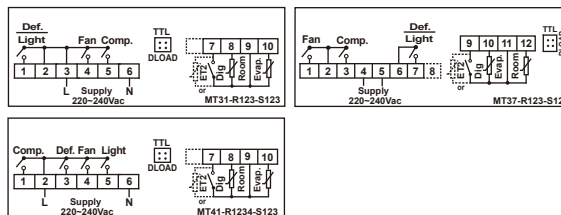

注: 更多接线图请翻阅详情表格。
 Note: Please refer to the detailed table for more wiring diagrams.

ABU3300参数表 Menu Parameters For Other version, please contact us.

Description		Range	Unit
User Menu			
St	Temperature SetPoint	C4...C5	℃/F
Management Menu			
PA	Manager menu password	0...99, master key=55	/
C1	Differential	0.1...50.0	℃/F
C2	Compressor start minimum interval	0...99	min
C3	Room probe calibration	-20.0...20.0	℃/F
C4	Minimum SetPoint	-50.0...St	℃/F
C5	Maximum SetPoint	St...99.9	℃/F
C6	Compressor initial start minimum interval	0...999	sec
d1	defrost probe selection	0=disable; 1=enable; 2=enable double defrost probe	/
d2	Defrost cycle	0...99, 0=Defrost forbidden	hr
d3	Maximum defrosting time	1...99	min
d4	Display lock during defrost	0= room temperature; 1=dEF; 2=Room temperature when defrosts starts,	/
d5	Room temperature display delay after defrost	0...99	min
d6	First defrosting interval after power on	10...999	min
d7	Defrost probe calibration	-20.0...20.0	℃/F
d8	Defrost stop temperature	-50.0...99.9	℃/F
d9	Dripping time after defrost	0...999	sec
d10	Defrost type	0=Electric; 1= Hot gas	/
d11	Defrost cycle calculation	0: cooling time; 1: natural time	/
d12	Defrost start output delay	0...999, 0=cancel defrost delay	sec
d13	Defrost at power-on	0=off; 1=on;	/
F1	Fan running mode	0=same with the compressor, OFF during	/
F2	Fan start delay after defrost	0...99	min
F3	Fan stop temperature	-50.0...99.9	℃/F
F4	Fan activation differential	0.1...50.0	℃/F
F5	Fan proportional on time if cool off	0...250, 0=off proportional running	sec
F6	Fan proportional off time if cool off	1...999	min
A1	Cooling proportional off time if probe fails	0...99	min
A2	Cooling proportional on time if probe fails	0...99, 0=continuously off	min
A3	Temperature alarm delay	0...999, 999=disable	min
A4	Temperature alarm delay at power-on	0...999,	min
A5	Temperature alarm delay after defrost	0...999	min
A6	Temperature alarm upper differential	0.1...50.0	℃/F
A7	Temperature alarm lower differential	0.1...50.0	℃/F
A8	Alarm exit differential	0.1...20.0	℃/F
A9	Display delay of 1℃/F increasing	0...999	sec
L1	Digital input polarity	0=disable and; 1=close valid; 2=open valid	/
L2	Digital signal valid, sound alarm output	0=off; 1=on	/
L3	Digital signal valid, fan output	0=off; 1=not effect	/
L4	Digital signal valid, sound alarm delay	0...999	sec
L5	Restart delay after door open and fan off	0...199	sec
L6	Digital signal valid, cooling stop delay	0...999, 0=disable off cooling	min
L7	deep cool mode start deviation(not with ECO)	0.1...40.0	℃/F
L8	deep cool mode stop deviation(not with ECO)	0.1...20.0	℃/F
L9	deep cool mode start detection time	0...999, 0=disable deep cool mode	min
L10	deep cool mode maximum working time	0.1...99.9	hr
L11	Door action count for start defrost	0...199, 0=disable start defrost	/
L12	Minimum cycle for door action to start defrost	1...999	min
L13	deep cool mode cycling continuous time	0...999	min
EC1	Enable ECO-DOOR mode	0=no; 1=yes	/
EC2	Time to activate ECO mode	1...500	min
EC3	Temperature differential of ECO mode	0.1...20.0	℃/F
EC4	Time to activate Store Closing Mode	1...500	min
EC5	Temperature differential in store close mode	0.1...20.0	℃/F
EC6	Number of actions to exit ECO mode	1...15	/
LC	Room temperature set point lock	0=lock; 1=unlock	/
P1	Set manager menu password	0...99, 0=not password	/
P5	Second relay function set	0=Light, Light is related to keys 1=Defrost, Light is related to keys 2=Light, Light is related to digital signal; 3=Defrost, Light is related to digital signal;	/
P9	℃/F selection	0=°F; 1=°C	/
AdU	Upload data interval (ABU series valid)	0...120, 0=disable	sec
Adr	Controller address (ABU series valid)	1...255	/

AH系列-湿度控制器

AH series - Humidity controller

AH100



产品型号信息 Model Info

产品系列 Model	软件型号 Software	压机继电器 Comp. relay	端子型号 Terminal	电网电压 Supply	主板型号 Mainboard	继电器 Relay	蜂鸣音 Buzzer	内部标识 Mark	传感器 Sensor		塑料壳 plastic shell	防爆 Explosion-proof
						R1			S1	T		
AH100	null N1...N99	H=2HP M=1HP L<=10A res.	T=Screw terminal V=NV Bar connect R=Plug terminal F=Tab terminal	null=AC220...240 A=AC100...127 W=AC100~240 D=DC8...60	10=AB-P10 31=AB-P31 37=AB-P37 ...	COMP.	B	E	Humidity	null=PH4 T=Screw	BK=Black shell BU=Blue shell BK1~BK99 BU1~BU99	EX

例: AH100-LT31-R1-S1-BK-EX, L <=10A res. COMPRESSOR, T=Screw terminal, 31=PCB model, R1=out relay, S1=Humidity sensor, BK=Black shell, EX=explosion-proof.

注: 上表仅为典型硬件配置, 如需了解详细情况, 请与我司联系. Note: The table only lists the typical hardware configuration. For more details, please contact us.

技术参数 Technical Parameters

额定电压: 220~240VAC, 短时最大过载电压 <264VAC/15min;

额定电压: 100~127VAC, 短时最大过载电压 <144VAC/15min

Rated voltage: 220~240VAC, Maximum overload voltage <264VAC/15min;

Rated voltage: 100~127VAC, Maximum overload voltage <144VAC/15min

整机功耗Consumption: ≤3W

测湿范围Display range: 0~99%RH

控湿范围Control range: 0~99%RH

测湿精度Accuracy(20~90%RH): 初始initial≈3%RH

分辨率Resolution: 1%RH

产品尺寸Dimensions(mm): 76.5×35, 深度Depth = 60

安装尺寸Mounting(mm): 71×29

接线图 Wiring diagrams

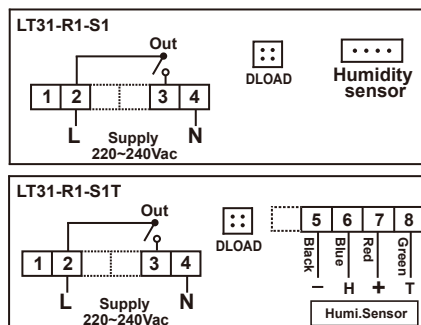

注: 更多接线图请翻阅详情表格.

Note: Please refer to the detailed table for more wiring diagrams.

参数表 Menu Parameters For Other version, please contact us.

	Description	Setting Range	Unit
St	setting value	C4...C5	%RH
PA	Management password	0...99, master key=55	/
C1	Differential	1...30	%RH
C2	Minimum output interval	0...99	min
C3	Probe calibration	-20...20	%RH
C4	Minimum setting range	0...St	%RH
C5	Maximum setting range	St...99	%RH
A1	Probe failure proportional stop time	0...99, 0=Always on	min
A2	Probe failure proportional on time	0...99, 0=Always off	min
A3	Over range alarm delay	0...99, 0=not alarm	min
A6	Upper deviation of humidity alarm	1...30	%RH
A7	Lower deviation of humidity alarm	1...30	%RH
P1	Set manager menu password	0...99, 0=not password	/
P4	control model	0=humidification; 1=dehumidification	/

AX系列 - 恒温控制器

AX series - Constant temperature controller

AX20

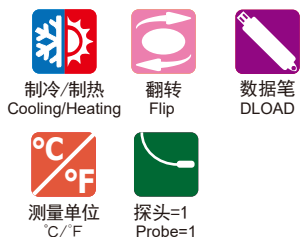

产品型号信息 Model Info

产品系列 Model	软件型号 Software	压缩机继电器 Comp. relay	端子型号 Terminal	电网电压 Supply	主板型号 Mainboard	继电器 relay					蜂鸣音 Buzzer	内部标识 Mark	传感器 Sensor S1	塑料壳 Plastic shell	防爆 Explosion-proof
						R1	R2	R3	R4	SPDT					
AX20	null N1...N99	H=2HP M=1HP L<=10A res.	T=Screw terminal V=NV Bar connect R=Plug terminal F=Tab terminal	null=AC220...240 A=AC100...127 W=AC100~240 D=DC8...60	33=AB-P33	Comp.	Timer	Heat	/	P33: Z=R2Z	/	E	RT	BK=Black shell BU=Blue shell BK1~BK99 BU1~BU99	EX

例: AX20-LT33-R123Z-S1-BK-EX, L<=10A res. COMPRESSOR, T=Screw terminal, 33=PCB model, R1=compressor relay, R2=hot relay, R3=time relay, Z=R2Z, S1=room probe, BK=Black shell, EX=explosion-proof.

注: 上表仅为典型硬件配置. 如需了解详细情况, 请与我司联系. Note: The table only lists the typical hardware configuration. For more details, please contact us.

技术参数 Technical Parameters

额定电压: 220~240VAC, 短时最大过载电压 <264VAC/15min;

额定电压: 100~127VAC, 短时最大过载电压 <144VAC/15min

Rated voltage: 220~240VAC, Maximum overload voltage <264VAC/15min;

Rated voltage: 100~127VAC, Maximum overload voltage <144VAC/15min

整机功耗 Consumption: ≤3W

测量范围 Display range: -50°C~99.9°C/199°F

控温范围 Control range: -50°C~99.9°C/F

测温精度 Accuracy: -40~70°C, ≤±1°C; others, ≤±2°C

分辨率 Resolution: -50~99.9°C/F, 0.1; others, 1

产品尺寸 Dimensions(mm): 76.5×35, 深度 Depth = 60

安装尺寸 Mounting(mm): 71×29

接线图 Wiring diagrams

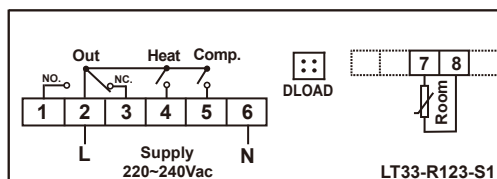

注: 更多接线图请翻阅详情表格.

Note: Please refer to the detailed table for more wiring diagrams.

参数表 Menu Parameters For Other version, please contact us.

	Description	Setting Range	Unit
User Menu			
St	Temperature set point	-50.0...99.9	°C/°F
Management Menu			
PA	Management password	0...99, master key=55	/
C1	Differential	0.1...50.0	°C/°F
C2	Compressor start minimum interval	0...999	sec
C3	Room probe calibration	-20.0...20.0	°C/°F
t1	Time switch	1...999	min
P1	Set manager menu password	0...99, 0=not password	/
P9	°C/°F selection	0=°F; 1=°C	/

AX系列 - 恒温控制器

AX series - Constant temperature controller

AX202/204

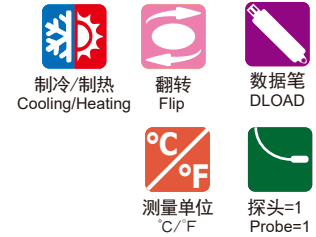

产品型号信息 Model Info

产品系列 Model	软件型号 Software	压缩机继电器 Comp. relay	端子型号 Terminal	电网电压 Supply	主板型号 Mainboard	继电器 relay					蜂鸣音 Buzzer	内部标识 Mark	传感器 Sensor S1	塑料壳 Plastic shell	防爆 Explosion-proof
						R1	R2	R3	R4	SPDT					
AX204	null N1...N99	H=2HP M=1HP L<=10A res.	T=Screw terminal V=NV Bar connect R=Plug terminal F=Tab terminal	null=AC220...240 A=AC100...127 W=AC100~240 D=DC8...60	43=AB-P43	OUT1	OUT2	OUT3	OUT4	P43: Z=R4Z	B	/	RT	BK=Black shell BU=Blue shell BK1~BK99 BU1~BU99	EX

例: AX204-LT43-R1234Z-S1-BK-EX, L<=10A res. COMPRESSOR, T=Screw terminal, 43=PCB model, R1=out1 relay, R2=out2 relay, R3=out3 relay, R4=out4 relay, Z=R4Z, S1=room probe, BK=Black shell, EX=explosion-proof.

注: 上表仅为典型硬件配置. 如需了解详细情况, 请与我司联系. Note: The table only lists the typical hardware configuration. For more details, please contact us.

技术参数 Technical Parameters

额定电压: 220~240VAC, 短时最大过载电压 <264VAC/15min;

额定电压: 100~127VAC, 短时最大过载电压 <144VAC/15min

Rated voltage: 220~240VAC, Maximum overload voltage <264VAC/15min;

Rated voltage: 100~127VAC, Maximum overload voltage <144VAC/15min

整机功耗 Consumption: ≤3W

测量范围 Display range: -50°C~99.9°C/199°F

控温范围 Control range: -50°C~99.9°C/°F

测温精度 Accuracy: -40~70°C, ≤±1°C; others, ≤±2°C

分辨率 Resolution: -50~99.9°C/°F, 0.1; others, 1

产品尺寸 Dimensions(mm): 76.5×35, 深度 Depth = 60

安装尺寸 Mounting(mm): 71×29

接线图 Wiring diagrams

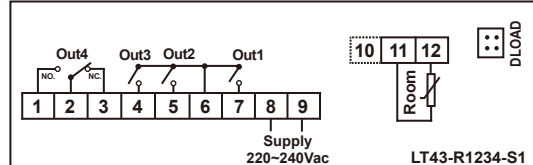

注: 更多接线图请翻阅详情表格.

Note: Please refer to the detailed table for more wiring diagrams.

参数表 Menu Parameters For Other version, please contact us.

menu	Description	Setting Range	unite
User menu			
St1	Output 1 SetPoint	-50.0...99.9...199	°C/°F
St2	Output 2 SetPoint	-50.0...99.9...199	°C/°F
St3	Output 3 SetPoint	-50.0...99.9...199	°C/°F
St4	Output 4 SetPoint	-50.0...99.9...199	°C/°F
Admin menu			
PA	Admin Password	0...99, 55=universal	/
tP1	Output 1 control mode	H = heating, C = cooling, T=timer, A=Alarm	/
dt1	Out 1 minimum start interval	0...999	sec
df1	Output 1 control differential	0.1...19.9	°C/°F
t7	Output 1 timer flip	5...999	sec
tP2	Output 2 control mode	H= heating, C = cooling, T=timer, A=Alamm	/
dt2	Out 2 minimum start interval	0...999	sec
df2	Output 2 control differential	0.1...19.9	°C/°F

t2	Output 2 timer flip	5...999	sec
tP3	Output 3 control mode	H = heating, C= cooling, T=timer, A=Alarm	/
dt3	Out 3 minimum start interval	0...999	sec
df3	Output 3 control differential	0.1...19.9	°C/°F
t3	Output 3 timer flip	5...999	sec
tP4	Output 4 control mode	H= heating, C = cooling, T=timer, A=Alarm	/
dt4	Out 4 minimum start interval	0...999	sec
df4	Output 4 control differential	0.1...19.9	°C/°F
t4	Output 4 timer flip	5...999	sec
HSP	Maximum SetPoint	LSP...99.9...199	°C/°F
LSP	Minimum SetPoint	-50.0...HSP	°C/°F
Cor	Probe calibration	-10.0-10.0	°C/°F
P1	Admin password settings	0...99, 0=cancel password	/
P9	°C/°F selection	F=Fahrenheit; C=Celsius	/

高温加热控制器 (200°C)

High temperature heating controller (200 °C)

AC2903



产品型号信息 Model Info

产品系列 Model	软件型号 Software	压机继电器 Comp. relay	端子型号 Terminal	电网电压 Supply	主板型号 Mainboard	继电器 Relay		蜂鸣音 Buzzer	显示表 Panel	内部标识 Mark	传感器 Sensor	塑料壳 Plastic shell	防爆 Explosion-proof
						R1	SPDT				S1		
AC290x	null N1...N99	H=2HP M=1HP L<=10A res.	T=Screw terminal V=NV Bar connect R=Plug terminal F=Tab terminal	null=AC220...240 A=AC100...127 W=AC100~240 D=DCB...60	10=AB-P10 20=AB-P20 23=AB-P23 31=AB-P31 35=AB-P35 37=AB-P37 44=AB-P44 ...	COMP.	P23/35: Z=R1Z P37: Z=R2Z P44: Z=R1Z	B	P	E	RT	BK=Black shell BU=Blue shell BK1-BK99 BU1-BU99	EX

例: AC2903-MT10-R1-S1-BK-EX, M=1HP COMPRESSOR, T=Screw terminal, 10=PCB model, R1=compressor relay, S1=room probe, BK=Black shell, EX=explosion-proof.

注: 上表仅为典型硬件配置, 如需了解详细情况, 请与我司联系. Note: The table only lists the typical hardware configuration. For more details, please contact us.

技术参数 Technical Parameters

额定电压: 220~240VAC, 短时最大过载电压 <264VAC/15min;

额定电压: 100~127VAC, 短时最大过载电压 <144VAC/15min

Rated voltage: 220~240VAC, Maximum overload voltage <264VAC/15min;

Rated voltage: 100~127VAC, Maximum overload voltage <144VAC/15min

整机功耗 Consumption: ≤3W

测量范围 Display range: -10°C~200°C/14°F~392°F

控温范围 Control range: -10°C~200°C/14°F~392°F

测温精度 Accuracy: ±2°C/±3°F

分辨率 Resolution: 1°C/1°F

产品尺寸 Dimensions(mm): 76.5×35, 深度 Depth = 44

安装尺寸 Mounting(mm): 71×29

接线图 Wiring diagrams

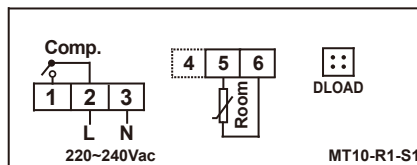

注: 更多接线图请翻阅详情表格.

Note: Please refer to the detailed table for more wiring diagrams.

参数表 Menu Parameters For Other version, please contact us.

Menu	Description	Setting Range	Unit
SEt	Temperature SetPoint	LSE...HSE	°C/°F
Pb1	View room probe temperature	-	°C/°F
PA1	Management password	00...250, 55=universal	/
CP			
diF	Differential	1...30	°C/°F
HSE	Maximum SetPoint	LSE...200°C/LSE...392°F	°C/°F
LSE	Minimum SetPoint	-10°C/14°F...HSE	°C/°F
HC	H=heating; C=cooling	H/C	/
Ont	Proportional cooling on time when Pb1 fails	0...250	min
OFt	Proportional cooling off time when Pb1 fails	0...250	min
dOn	Compressor delay after request	0...250	sec
dOF	Delay after switching off and subsequent activation.	0...250	min
dbi	Minimum time between compressor on-off	0...250	min
OdO	Output delay when controller power on	0...250	min
diS			
LOC	Temperature setpoint lock	y=lock; n=unlock	/
PA1	Management password set	0...250	/
CA1	Room temperature probe calibration	-12...12	°C/°F
dro	°C/°F selection	00=°C; 01=°F	/
CnF			
H00	Probe type selection	ntC=NTC	/
FPp			
UL	Parameters uploaded to Data pencil	/	/
Fr	Format Data pencil	/	/

AM系列-低温控制器 (-100°C) AM series - Low Temperature Controller (-100°C)

AM3300



产品型号信息 Model Info

产品系列 Model	软件型号 Software	压机继电器 Comp. relay	端子型号 Terminal	电网电压 Supply	主板型号 Mainboard	继电器 Relay				蜂鸣音 Buzzer	显示表 Panel	内部标识 Mark	传感器 Sensor			塑料壳 Plastic shell	防爆 Explosion-proof	
						R1	R2	R3	R4				SPDT	S1	S2			S3
AM3300	null N1...N99	H=2HP M=1HP L<=10A res.	T=Screw terminal V=NV Bar connect R=Plug terminal F=Tab terminal	null=AC220...240 A=AC100...127 W=AC100~240 D=DC3...60	31=AB-P31 35=AB-P35 37=AB-P37 41=AB-P41 44=AB-P44 ...	COMP.	DEF	FAN	LIGHT	P35/44: Z=R1Z P37: Z=R2Z	B	P	E	RT	ET	DT	BK=Black shell BU=Blue shell BK1~BK99 BU1~BU99	EX

例: AM3300-MT37-R123-S123-BK-EX, M=1HP COMPRESSOR, T=Screw terminal, 37=PCB model, R1=compressor relay, R2=defrost relay, R3=fan relay, S1=room probe, S2=defrost probe, S3=Dig probe, BK=Black shell, EX=explosion-proof.

注: 上表仅为典型硬件配置, 如需了解详细情况, 请与我司联系。 Note: The table only lists the typical hardware configuration. For more details, please contact us.

技术参数 Technical Parameters

额定电压: 220~240VAC, 短时最大过载电压 <264VAC/15min;
 额定电压: 100~127VAC, 短时最大过载电压 <144VAC/15min;
 Rated voltage: 220~240VAC, Maximum overload voltage <264VAC/15min;
 Rated voltage: 100~127VAC, Maximum overload voltage <144VAC/15min
 整机功耗Consumption: ≤3W
 测量范围Display range: -99.9°C~50.0°C/122°F
 控温范围Control range: -99.9°C~50.0°C/122°F
 测温精度Accuracy: ±1°C/°F
 分辨率Resolution: 0.1°C/°F
 产品尺寸Dimensions(mm): 76.5×35, 深度Depth = 60
 安装尺寸Mounting(mm): 71×29

接线图 Wiring diagrams

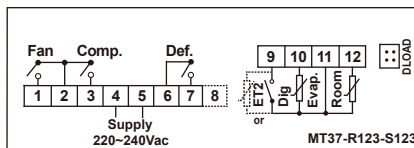

注: 更多接线图请翻阅详情表格。
 Note: Please refer to the detailed table for more wiring diagrams.

参数表 Menu Parameters For Other version, please contact us.

Menu	Description	Range	Unit
User Menu			
St	Temperature SetPoint	C4..C5	°C/°F
Management Menu			
PA	Manager menu password	0..99, master key=55	/
C1	Differential	0.1..50.0	°C/°F
C2	Compressor start minimum interval	0..99	min
C3	Room probe calibration	-20.0..20.0	°C/°F
C4	Minimum SetPoint	99.9..5t	°C/°F
C5	Maximum SetPoint	5t..50.0	°C/°F
C6	Compressor initial start minimum interval	0..999	sec
d1	defrost probe selection	0=disable; 1=enable	/
d2	Defrost cycle	0..99, 0=Defrost forbidden	hr
d3	Maximum defrosting time	1..99	min
d4	Display lock during defrost	0=room temperature; 1=dEF; 2=Room temperature when defrosts starts;	/
d5	Room temperature display delay after defrost	0..99	min
d6	First defrosting interval after power on	10..999	min
d7	defrost probe calibration	20.0..20.0	°C/°F
d8	Defrost stop temperature	99.9..50.0	°C/°F
d9	Dripping time after defrost	0..999	sec
d10	Defrost type	0=Electric; 1= Hot gas	/
d11	Defrost cycle calculation	0: cooling time; 1: natural time	/
d12	Defrost start output delay	0..999, 0=cancel defrost delay	sec
d13	Defrost at power-on	0=off; 1=on	/
F1	Fan running mode	0=same with the compressor, OFF during defrost; 1=continuous mode, OFF during defrost; 2=same with the compressor, ON during defrost; 3=continuous mode	/
F2	Fan start delay after defrost	0..99	min
F3	Fan stop temperature	99.9..50.0	°C/°F
F4	Fan activation differential	0.1..50.0	°C/°F
F5	Fan proportional on time if cool off	0..250, 0=off proportional running	sec
F6	Fan proportional off time if cool off	1..999	min
A1	Cooling proportional off time if probe fails	0..99	min
A2	Cooling proportional on time if probe fails	0..99, 0=continuously off	min
A3	Temperature alarm delay	0..999, 999=disable	min
A4	Temperature alarm delay at power-on	0..999,	min
A5	Temperature alarm delay after defrost	0..999	min
A6	Temperature alarm upper differential	0.1..50.0	°C/°F
A7	Temperature alarm lower differential	0.1..50.0	°C/°F
A8	Alarm exit differential	0.1...20.0	°C/°F
A9	Display delay of 1°C/°F increasing	0..999	sec
L1	Digital input polarity	0=disable; 1=close valid; 2=open valid	/
L2	Digital signal valid, sound alarm output	0=off; 1=on	/
L3	Digital signal valid, Fan output	0=off; 1=not effect	/
L4	Digital signal valid, sound alarm delay	0..999	sec
L5	Restart delay after door open and fan off	0..199	sec
L6	Digital signal valid, cooling stop delay	0..999, 0=disable off cooling	min
L7	deep cool mode start deviation(not with ECO)	0.1...40.0	°C/°F
L8	deep cool mode stop deviation(not with ECO)	0.1...20.0	°C/°F
L9	deep cool mode start detection time	0..999, 0=disable deep cool mode	min
L10	deep cool mode maximum working time	0.1..99.9	hr
L11	Door action count for start defrost	0..199, 0=disable start defrost	/
L12	Minimum cycle for door action to start defrost	1..999	min
L13	deep cool mode cycling continuous time	0..999	min
LC	Room temperature set point lock	0=lock; 1=unlock	/
P1	Set manager menu password	0..99, 0=not password	/
PS	Second relay function set	0=Light, Light is related to keys 1=Defrost, Light is related to keys 2=Light, Light is related to digital signal; 3=Defrost, Light is related to digital signal;	/
P9	°C/°F selection	0=°F; 1=°C	/
AdU	Upload data interval (ABU series valid)	0..120, 0=disable	sec
Adr	Controller address (ABU series valid)	1..255	/

AC系列-兼容型控制器

AC series - Compatible controller

AC1020/1060



制冷/制热
Cooling/Heating



除霜
Defrost



风机
Fan



灯光
Light



报警
Alarm



探头≤3
Probes≤3



数据笔
DLOAD



测量单位
°C/°F



产品型号信息 Modle Info

产品系列 Model	软件型号 Software	压机继电器 Comp. relay	端子型号 Terminal	电网电压 Supply	主板型号 Mainboard	继电器 Relay				蜂鸣音 Buzzer	显示表 Panel	内部标识 Mark	传感器 Sensor			塑料壳 Plastic shell	防爆 Explosion-proof
						R1	R2	R3	SPDT				S1	S2	S3		
AC1060	null	H=2HP M=1HP L<=10A res.	T=Screw terminal V=NV Bar connect R=Plug terminal F=Tab terminal	null=AC220...240 A=AC100...127 W=AC100...240 D=DC8...60	10=AB-P10 20=AB-P20 23=AB-P23 31=AB-P31 35=AB-P35 37=AB-P37 44=AB-P44	COMP.	DEF	FAN	P23/35: Z=R1Z P37: Z=R2Z P44: Z=R1Z	B	P	E	RT	ET	DT	BK=Black shell BU=Blue shell BK1~BK99 BU1~BU99	EX
AC1020	N1...N99							/						DT	/		

例: AC1020-MT37-R1E-S12-BK-EX, M=1HP COMPRESSOR, T=Screw terminal, 37=PCB model, R1=compressor relay, E=chip model, S1=room probe, S2=defrost probe, BK=Black shell, EX=explosion-proof.

注: 上表仅为典型硬件配置, 如需了解详细情况, 请与我司联系。 Note: The table only lists the typical hardware configuration. For more details, please contact us.

技术参数 Technical Parameters

额定电压: 220~240VAC, 短时最大过载电压 <264VAC/15min;

额定电压: 100~127VAC, 短时最大过载电压 <144VAC/15min

Rated voltage: 220~240VAC, Maximum overload voltage <264VAC/15min;

Rated voltage: 100~127VAC, Maximum overload voltage <144VAC/15min

整机功耗Consumption: ≤3W

测量范围Display range: -50°C~99.9°C/-58°F~210°F

控温范围Control range: -50°C~99°C/°F

测温精度Accuracy: -40~70°C, ±1°C; others, ±2°C

分辨率Resolution: 0.1°C/1°F

产品尺寸Dimensions(mm): 76.5×35, 深度Depth = 60或61或44

安装尺寸Mounting(mm): 71×29

接线图 Wiring diagrams

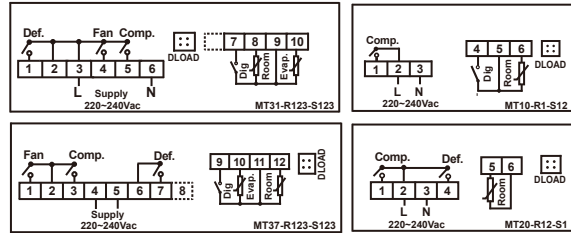

注: 更多接线图请翻阅详情表格。

Note: Please refer to the detailed table for more wiring diagrams.

参数表 Menu Parameters For Other version, please contact us.

Men	Description	Setting Range	1020	1060	layer	unit
St	Temperature set point	LS...US	3	3	Pr0	°C/°F
Hy	Temperature differential	0.1°C...10.0°C/1°F...20°F	2	2	Pr1	°C/°F
LS	Minimum temp. setting	-50...St	-50	-50	Pr2	°C/°F
US	Maximum temp. setting	St...99	99	99	Pr2	°C/°F
ot	Storage probe calibration	-9.9°C...9.9°C/-20°F...20°F	0	0	Pr1	°C/°F
P2	Activate defrost probe	y=yes; n=no	y	y	Pr1	-
oE	Defrost probe calibration	-9.9°C...9.9°C/-20°F...20°F		0	Pr2	°C/°F
od	Power on output delay	0...99	0	0	Pr2	min
AC	Anti frequent start delay	0...99	1	1	Pr1	min
Cy	Proportional on time when temperature probe fails	0...99	15	15	Pr2	min
Cn	Proportional off time when temperature probe fails	0...99	30	30	Pr2	min
CH	Cooling/Heating mode	CL=Cooling; Ht=Heating	CL	CL	Pr2	-
CF	Celsius/Fahrenheit option	C=Celsius, F=Fahrenheit	C	C	Pr2	-
ld	Temperature display	P1=Room temperature; P2=Defrost probe temperature;		P1	Pr2	-
dy	Time of every 1°C/°F rising	00...20	0	0	Pr2	min
td	Defrost type	EL=Electric heating; in=Hot gas		EL	Pr2	-
dE	Defrost stop temperature	-50...90		8	Pr1	°C/°F
id	Defrost circle	0...99, 0=disable	8	8	Pr1	hour
Md	Maximum defrost time	1...99	20	20	Pr1	min
dd	Defrost delay	0...99; 0=disable		0	Pr2	min
dF	Display during defrost	rt=room temperature; ft=temperature when defrost starts St=temperature set point; dF=dF	it	it	Pr2	-
dt	Dripping time after defrost	0...99; 0=disable dripping		0	Pr2	min
dP	Power on defrost	y=yes; n=no		n	Pr2	-
FC	Fan mode	Cn=synchronize with cooling; stop when defrost; Z=synchronize with cooling; start when defrost; on=Continue working, stop when defrost, Oy=continue working		on	Pr1	-
Fd	Fan start delay after defrost	0...99		10	Pr1	min
FS	Fan stop temperature	-50...90		0	Pr2	°C/°F
AU	Upper alarm temperature	(AL+1)...99		99	Pr2	°C/°F
AL	Lower alarm temperature	-50...(AU-1)		-50	Pr1	°C/°F
Ad	Alarm delay	0...99		15	Pr2	min
dA	Alarm delay after power on	0...99		90	Pr2	min
o1	Auxiliary relay option	dF=Defrost; AL=Alarm; Au=Auxiliary output		Au	Pr2	-
IP	Digital signal polarity	oP=Open valid; cL=close valid		CL	Pr2	-
if	Digital input function	EA=Normal alarm, display EA; bA=Severe alarm, display CA; do=Door open alarm, display dA; dF=Defrost; AU=Auxiliary relay(AC1040/1060 invalid); HC=Heating/Cooling(AC1040/1060 invalid)		EA	Pr2	-
di	Digital input alarm delay	0~99min(F=EA, bA, do valid)		5	Pr2	min
dC	Door open output status	no=unchanged; CP=off compressor; Fn=off can only(AC1020/1030 invalid); FC=(AC1020/1030 invalid);		no	Pr2	-

AC系列-兼容型控制器

AC series - Compatible controller

AC2902/2961/2974



产品型号信息 Model Info

产品系列 Model	软件型号 Software	压机继电器 Comp. relay	端子型号 Terminal	电网电压 Supply	主板型号 Mainboard	型号后缀 Model suffix	继电器 Relay				蜂鸣音 Buzzer	显示表 Panel	内部标识 Mark	传感器 Sensor		塑料壳 Plastic shell	防爆 Explosion-proof
							R1	R2	R3	SPDT				S1	S2		
AC2974	null N1...N99	H=2HP M=1HP L<=10A res.	T=Screw terminal V=NV Bar connect R=Plug terminal F=Tab terminal	null=AC220...240 A=AC100...127 W=AC100~240 D=DC8...60	10=AB-P10 20=AB-P20 23=AB-P23 31=AB-P31 35=AB-P35 37=AB-P37 44=AB-P44 ...	AC2974: P=AC2974P (AC2974+S3) AC2961: P=AC2961P (AC2961+S2)	COMP.	DEF	FAN	P23/35: Z=R1Z P37: Z=R2Z P44: Z=R1Z	B	P	E	RT	ET	BK=Black shell BU=Blue shell BK1~BK99 BU1~BU99	EX
AC290x AC296x																	

例: AC2902-LT10-R1E-S1-BK-EX, L<=10A res.COMPRESSOR, T=Screw terminal, 10=PCB model, R1=compressor relay, E=chip model, S1=room probe, BK=Black shell, EX=explosion-proof.

注: 上表仅为典型硬件配置, 如需了解详细情况, 请与我司联系. Note: The table only lists the typical hardware configuration. For more details, please contact us.

技术参数 Technical Parameters

额定电压: 220~240VAC, 短时最大过载电压 < 264VAC/15min;
 额定电压: 100~127VAC, 短时最大过载电压 < 144VAC/15min
 Rated voltage: 220~240VAC, Maximum overload voltage < 264VAC/15min;
 Rated voltage: 100~127VAC, Maximum overload voltage < 144VAC/15min
 整机功耗 Consumption: ≤ 3W
 测量范围 Display range: -50°C ~ 99.9°C / 199°F
 控温范围 Control range: -50°C ~ 99.9°C / F
 测温精度 Accuracy: -40~70°C, ±1°C; others, ±2°C
 分辨率 Resolution: -50~99.9°C/°F, 0.1; others, 1
 产品尺寸 Dimensions(mm): 76.5×35, 深度 Depth = 60或61或44
 安装尺寸 Mounting(mm): 71×29

接线图 Wiring diagrams

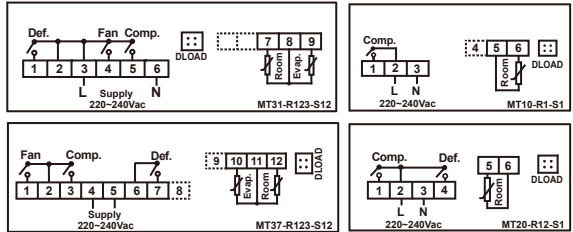

注: 更多接线图请翻阅详情表格.
 Note: Please refer to the detailed table for more wiring diagrams.

参数表 Menu Parameters For Other version, please contact us.

Description	Setting Range	2902	2961	2974	Unit
AL Temperature alarm message	-	-	-	-	-
SEt Temperature setpoint	LSE...HSE	0	0	0	°C/°F
Pb1 View room probe temperature	-	-	-	-	°C/°F
Pb2 View defrost probe temperature	#VALUE!	-	-	-	°C/°F
PA1 Management password input	00...250, master key=55	-	-	-	/
CP					
dIF Differential	0.1...30.0	2	2	2	°C/°F
HSE Maximum SetPoint	LSE...99.9°C/LSE...200°F	90	90	90	°C/°F
LSE Minimum SetPoint	-50.0...HSE	-50	-50	-50	°C/°F
HC H=heating; C=cooling	H/C	C	C	C	/
Ort Proportional cooling on time when Pb1 fails	0...250	0	0	0	min
OfT Proportional cooling off time when Pb1 fails	0...250	1	1	1	min
dOn Compressor delay after request	0...250	0	0	0	sec
dOf Delay after switching off and subsequent activation.	0...250	0	0	0	min
dbi Minimum time between compressor on-off	0...250	0	0	0	min
OdO Output delay when controller power on	0...250	0	0	0	min
DEF					
dty Defrost type	0=electric defrost 1=hot gas defrost 2=off compressor defrost			0	/
dit Defrost cycle	0...250; 0=defrost forbidden		6	6	hr
dct Defrost counting type	0=Sum of cooling on time 1=natural time; 2=Sum of cooling off time		1	1	/
dOH Defrost delay time after power on	0...99		0	0	min
dEt Defrost endurance time	1...99		30	30	min
dSt Defrost stop temperature	-50.0...99.9		8	8	°C/°F
dPO Defrost at power on	n/y		n	n	/
FAN					
FSt Fan stop temperature	-50.0...99.9			2	°C/°F
FAd Fan differential	1.0...50.0			2	°C/°F
Fdt Fan delay time	0...250			0	min
dt Dripping time	0...250			0	min
dFd Defrost fan disable. Allows evaporator fan exclusion to be selected or not selected during defrosting. n (0) = no (it depends on FCO parameter); y (1) = yes (fans excluded).	n=on; y=off;			y	/
FCO Fan operation mode	n= according to defrosting temp, fan off when cooling is off. y=according to defrosting			y	/
AL					
AfD Alarm differential	0.1...50.0			2	°C/°F
HAL Maximum temperature alarm	LAL...99.9°C/LAL...200°F		50	50	°C/°F
LAL Minimum temperature alarm	-50.0...HAL		-50	-50	°C/°F
PAO Room temperature delay alarm time after power-on	0...10		0	0	hr
dAO Alarm delay after defrosting circle	0...250		0	0	min
tAO Room temperature alarm delay	0...250		0	0	min
dIS					
LOC Temperature setpoint lock	y=locked; n=unlocked		n	n	/
PA1 Management password set	0...250		0	0	/
ndt Decimals of temperatures	y=decimal; n=integer		y	y	/
CA1 Room temperature probe calibration	-12.0...12.0		0	0	°C/°F
CA2 Defrost probe calibration	-12.0...12.0		0	0	°C/°F
ddl Defrost display lock	0=room temperature 1=room temperature when 2=dEF code		1	1	/
dro °C/°F selection	00=°C; 01=°F		0	0	/
CnF					
H00 Probe type selection	ntC=NTC		ntC	ntC	/
H42 Defrost probe	n=off; y=on		y	y	/
FPr					
UL Parameters uploaded to DLoad	/		/	/	/
Fr Format DLoad	/		/	/	/

AC系列-兼容型控制器

AC series - Compatible controller

AC2961PLUS/2974PLUS



制冷
Cooling



除霜
Defrost



风机
Fan



探头≤3
Probe≤3



数据笔
Probe=2



测量单位
DLOAD



调节0.1
Adjust 0.1



产品型号信息 Model Info

产品系列 Model	软件型号 Software	压机继电器 Comp. relay	端子型号 Terminal	电网电压 Supply	主板型号 Mainboard	型号后缀 Model suffix	继电器 Relay				蜂鸣音 Buzzer	显示表 Panel	内部标识 Mark	传感器 Sensor			塑料壳 Plastic shell	防爆 Explosion-proof
							R1	R2	R3	SPDT				S1	S2	S3		
AC2974	null	H=2HP M=1HP L<=10A res.	T=Screw terminal V=NV Bar connect R=Plug terminal F=Tab terminal	null=AC220...240 A=AC100...127 W=AC100~240 D=DC8...60	10=AB-P10 20=AB-P20 23=AB-P23 31=AB-P31 35=AB-P35 37=AB-P37 44=AB-P44 ...	AC2974: P=AC2974P (AC2974+S3) AC2961: P=AC2961P (AC2961+S2)	FAN	P23/35: Z=R1Z	P37: Z=R2Z	P44: Z=R1Z	B	P	E	RT	ET	DT	BK=Black shell BU=Blue shell BK1~BK99 BU1~BU99	EX
AC296x	N1...N99						/								DT	/		

例: AC2974-LT31P-R1-S123-BK-EX, L<=10A res. COMPRESSOR, T=Screw terminal, 31=PCB model, P=AC2974P (AC2974+S3), R1=compressor relay, S1=room probe, S2=defrost probe, S3=Dig probe, BK=Black shell, EX=explosion-proof.

注: 上表仅为典型硬件配置, 如需了解详细情况, 请与我司联系。 Note: The table only lists the typical hardware configuration. For more details, please contact us.

技术参数 Technical Parameters

额定电压: 220~240VAC, 短时最大过载电压<264VAC/15min;

额定电压: 100~127VAC, 短时最大过载电压 <144VAC/15min

Rated voltage: 220~240VAC, Maximum overload voltage<264VAC/15min;

Rated voltage: 100~127VAC, Maximum overload voltage <144VAC/15min

整机功耗Consumption: ≤3W

测量范围Display range: -50°C~99.9°C/199°F

控温范围Control range: -50°C~99.9°C/F

测温精度Accuracy: -40~70°C, ≤±1°C; others, ≤±2°C

分辨率Resolution: -50~99.9°C/F, 0.1; others, 1

产品尺寸Dimensions(mm): 76.5×35, 深度Depth = 44或60或61

安装尺寸Mounting(mm): 71×29

接线图 Wiring diagrams

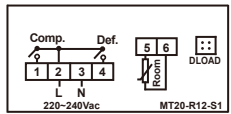
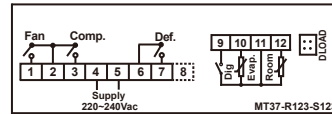
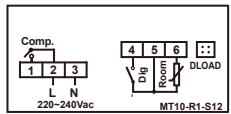
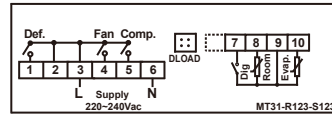

注: 更多接线图请翻阅详情表格。

Note: Please refer to the detailed table for more wiring diagrams.

参数表 Menu Parameters For Other version, please contact us.

Description	Setting Range	2961P	2974P	Unit
AL Temperature alarm message	AH1/AL1/OPd	-	-	-
SB Temperature setpoint	LSE..HSE	0	0	°C/F
Pb1 View room probe temperature	-	-	-	°C/F
Pb2 View defrost probe temperature	-	-	-	°C/F
PA1 Management password input	00...250, master key=55	-	-	/
CP				
dIF Differential	0.1...30.0	2	2	°C/F
HSE Maximum SetPoint	LSE..99.9°C/LSE..200°F	90	90	°C/F
LSE Minimum SetPoint	-50.0..HSE	-50	-50	°C/F
Ort Proportional cooling on time when Pb1 fails	0..250	0	0	min
OfT Proportional cooling off time when Pb1 fails	0..250	1	1	min
dOn Compressor delay after request	0..250	0	0	sec
dOF Delay after switching off and subsequent activation	0..250	0	0	min
dbi Minimum time between compressor on-off	0..250	0	0	min
dOd Output delay when controller power on	0..250	0	0	min
dEF				
dty Defrost type	0=electric defrost; 1=hot gas defrost; 2=off compressor defrost		0	/
dit Defrost cycle	0..250; 0=defrost forbidden	6	6	hr
dCt Defrost counting type	0=Sum of cooling on time; 1=natural time; 2=Sum of cooling off time	1	1	/
dOH Defrost delay time after power on	0..99	0	0	min
dEt Defrost endurance time	1...99	30	30	min
dSt Defrost stop temperature	-50.0..99.9		8	°C/F
dPO Defrost at power on	n/y	n	n	/
FAN				
FSt Fan stop temperature	-50.0..99.9		2	°C/F
FAd Fan differential	1.0...50.0		2	°C/F
Fdt Fan delay time	0..250		0	min
dt Dripping time	0..250		0	min
dFd Defrost fan disable, n=no(it depends on FCO parameter); y=yes (fans excluded).	n=on; y=off		y	/
FCO Fan operation mode	n= according to defrosting temp, fan off when cooling is off; y=according to defrosting		y	/
AL				
AfD Alarm differential		0.1...50.0	2	2
HAL Maximum temperature alarm	LAL..99.9°C/LAL..200°F		50	50
LAL Minimum temperature alarm	-50.0..HAL		-50	-50
PAO Room temperature delay alarm time after power-on	0..10		0	0
dAO Alarm delay after defrosting circle	0..250		0	0
OAO Alarm delay after door close	0..10		0	0
tdO Time out door open	0..250		0	0
IAO Room temperature alarm delay	0..250		0	0
LR				
dOd Digital signal action of door open	0=no action; 1=off fan; 2=off compressor; 3=off compressor and		0	0
dAd Digital signal action delay	0..250		0	0
dCO Compressor off delay after digital signal action	0..250		1	1
AuP AUX output after door open	n=no effect; y=AUX synchronize with door open or close		n	n
dIS				
LOC Temperature setpoint lock	y=locked; n=unlocked		n	n
PA1 Management password set	0..250		0	0
ndt Decimals of temperature	y=decimal; n=integer		y	y
CA1 Room temperature probe calibration	-12.0..12.0		0	0
CA2 Defrost probe calibration	-12.0..12.0		0	0
ddl Defrost display lock	0=room temperature; 1=room temperature when defrosts on; 2=dEF code		1	1
Ldd Timeout value for Defrost display unlock	0..250		30	30
dro °C/F selection	00=°C; 01=°F		0	0
CnF				
H00 Probe type selection	ntC=NTC		ntC	ntC
H11 Dig1 configuration	-9..9, a3=AUX, a4=Door Switch, other=no		0	0
H22 Configurability of digital output 2	0...6, 2=defrost, other=AUX		2	2
H42 Defrost probe	n=off; y=on		y	y
FPF				
UL Parameters uploaded to DLoad	/		/	/
Fr Format DLoad	/		/	/

AC系列-兼容型控制器

AC series - Compatible controller

AC3961/3974



节能模式 ECO	制冷/制热 Cooling/Heating	AUX	风机 Fan	除霜 Defrost	报警 Alarm	压力保护 Pressure-switch
探头≤3 Probes3	扩展显示 Ext-display	测量单位 °C/°F	速冻模式 Quick-freezing	数据笔 DLOAD	电源控制 Standby	调节0.1 Adjust 0.1

产品型号信息 Model Info

产品系列	软件型号	压机继电器	端子型号	电网电压	主板型号	继电器				蜂鸣音	显示表	内部标识	传感器			塑料壳	防爆
						R1	R2	R3	SPDT				S1	S2	S3		
AC3974	null	H=2HP M=1HP L<=10A res.	T=Screw terminal V=NV Bar connect R=Plug terminal F=Tab terminal	null=AC220...240 A=AC100...127 W=AC100~240 D=DC8...60	10=AB-P10 20=AB-P20 23=AB-P23 31=AB-P31 35=AB-P35 37=AB-P37 44=AB-P44	COMP.	DEF	FAN	P23/S5: Z=R1Z P37: Z=R2Z P44: Z=R1Z	B	P	E	RT	ET	DT	BK=Black shell BU=Blue shell BK1-BK99 BU1-BU99	EX
AC3961	N1...N99							/						DT	/		

例: AC3961-MT37-R1-S123-BK-EX, M=1HP COMPRESSOR, T=Screw terminal, 37=PCB model, R1=compressor relay, S1=room probe, S2=defrost probe, S3=Dig probe, BK=Black shell, EX=explosion-proof.

注: 上表仅为典型硬件配置, 如需了解详细情况, 请与我司联系。 Note: The table only lists the typical hardware configuration. For more details, please contact us.

技术参数 Technical Parameters

额定电压: 220~240VAC, 短时最大过载电压 <264VAC/15min;
 额定电压: 100~127VAC, 短时最大过载电压 <144VAC/15min;
 Rated voltage: 220~240VAC, Maximum overload voltage <264VAC/15min;
 Rated voltage: 100~127VAC, Maximum overload voltage <144VAC/15min
 整机功耗Consumption: ≤3W
 测量范围Display range: -50~99°C/199°F
 控温范围Control range: -50°C~99°C/199°F
 测温精度Accuracy: -40~70°C, ±1°C; others, ±2°C
 分辨率Resolution: -50~99.9°C/°F, 0.1; others, 1
 产品尺寸Dimensions(mm): 76.5×35, 深度Depth = 61或60或44
 安装尺寸Mounting(mm): 71×29

接线图 Wiring diagrams

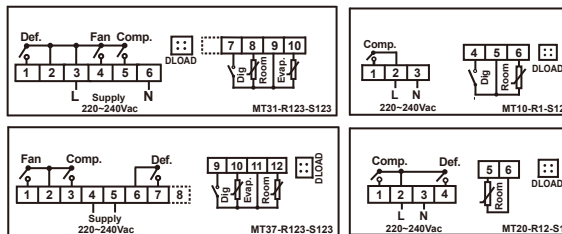

注: 更多接线图请翻阅详情表格。
 Note: Please refer to the detailed table for more wiring diagrams.

用户参数表 User Menu Parameters For Other version, please contact us.

Description					
AL Alarm code view	H42 Probe Pb2 present	FnF Fan proportional off time at night	PS1 User menu password set		
SEt Storage set value	H43 Probe Pb3 present	ESF Activate night mode	PS2 Management password set		
Pb1 Storage probe temperature	Men Description	AL folder	ndt Display with decimal point		
Pb2 Defrost probe temperature	CP folder	Att HAL/LAL value choose	CA1 Pb1 calibration(storage probe)		
Pb3 Pb3 probe temperature	dIF Control differential	AfD Alarm fan differential	CA2 Pb2 calibration(defrost probe)		
User menu (Parameters in shadow part can be hidden)	HSE Maximum possible setpoint value	HAL Higher alarm	CA3 Pb3 calibration		
Men Description	LSE Minimum possible setpoint value	LAL Lower alarm	dDL Display mode during defrost		
dIF Control differential	OSP Control point change in ECO mode	PAO Power-on alarm override	Ldd Timeout value for display unlock-label dEF		
HSE Maximum setpoint	HC Cooling/Heating selection	dAO Alarm delay after defrost	dro Select the unit of measurement		
LSE Minimum setpoint	Ont Compressor on time	OAO Alarm delay after door close	ddd Select value to show in display		
dty Defrost type	OFt compressor off time	tAO Time out door open	HCP folder		
dit Defrost circle	don Compressor output delay	tAO Temperature alarm delay	SHH Maximum HACCP alarm threshold		
dEt Defrost time	dOF Compressor off delay	rLO External alarm lock	SLH Minimum HACCP alarm threshold		
dSt Defrost stop temperature	dbi Compressor on delay	dAt Defrost alarm time	dra Minimum dwelling time in critical area for the event to be recorded.		
FSt Fan off temperature	OdO Delay output from power on	SA3 Pb3 alarm setpoint	dH4 HACCP alarm reset time from last reset		
Fdt Fan delay after defrost	dCS Quick freezing temperature set	dA3 Pb3 alarm differential	H50 HACCP character		
dt Dripping time	tdC Time durance of fast cooling	Lit folder	H51 HACCP alarm override time		
dFd Fan off if defrosts start	dcc Defrost delay after quick freezing	dOd Digital signal action of door open			
HAL Higher Alarm	dEF folder	dAd Digital signal action delay			
LAL Lower Alarm	dty Defrost type	dCO Compressor off delay after digital signal action			
SA3 Pb3 alarm setpoint	dit Defrost circle (defrost interval)	AuP AUX output after door open			
LOC Basic commands edit lock	dCt Defrost circle counting method	PrE folder			
PS1 User menu password set	dOH Power on defrost delay	PEn Number of errors allowed per maximum/minimum pressure switch input.			
CA1 Storage probe calibration	dEt Defrost endurance time	PEI Minimum/maximum pressure switch error count interval			
CA2 Defrost probe calibration	dSt Defrost stop temperature	PEt Delay in deactivating compressor after door opened.			
CA3 Pb3 Probe calibration	dPO Defrost at power on	Add folder			
dDL Display mode during defrost	FAn folder	PS Selection of communication protocol.			
Ldd Timeout value for display unlock-label-dEF	FSt Fan stop temperature	dEA Device address; indicates the device address to the management protocol.			
SHH Maximum HACCP alarm threshold	FAd Fan starting differential	FAA Family address; indicates the device family to the management protocol.			
SLH Minimum HACCP alarm threshold	Fdt Fan delay time	Pty Modbus parity bit.			
dra Minimum dwelling time in critical area for the event to be recorded.	dt Dripping time	STP Modbus stop bit.			
dH4 HACCP alarm reset time from last reset	dFd Defrost fan disable	diS folder			
H50 HACCP character	FCO Fan running mode	LOC Basic commands edit lock			
H51 HACCP alarm override time	FOn Fan proportional on time in daytime				
	FOF Fan proportional off time in				
	Fnn Fan proportional on time at night				

AC系列-兼容型控制器

AC series - Compatible controller

AC4020



产品型号信息 Model Info

产品系列 Model	软件型号 Software	压机继电器 Comp. relay	端子型号 Terminal	电网电压 Supply	主板型号 Mainboard	型号后缀 Model suffix	继电器 Relay			蜂鸣音 Buzzer	显示表 Panel	内部标识 Mark	传感器 Sensor			塑料壳 Plastic shell	防爆 Explosion-proof	
							R1	R2	R3				S1	S2	S3			
AC4020	null N1...N99	H=2HP M=1HP L=10A	T=Screw terminal V=NV Bar connect R=Plug terminal F=Tab terminal	null=AC220...240 A=AC100...127 W=AC100~240 D=DC7...60	10=AB-P10 20=AB-P20 23=AB-P23 31=AB-P31 35=AB-P35 37=AB-P37 44=AB-P44	AC4020: C=AC4020C(PJ EZ C) X=AC4020X(PJ EZ X) Y=AC4020Y(PJ EZ Y) S=AC4020S(PJ EZ S)	COMP.	DEF	FAN	P23/35: Z=R1Z P37: Z=R2Z P44: Z=R1Z	B	P	E	RT	ET	DT	BK=Black shell BU=Blue shell BK1-BK99 BU1-BU99	EX

例: AC4020-MT37S-R1B-S123-BK-EX, M=1HP COMPRESSOR, T=Screw terminal, 37=PCB model, S=AC4020S(PJ EZ S), R1=compressor relay, B=Buzzer, S1=room probe, S2=defrost probe, S3=Dig probe, BK=Black shell, EX=explosion-proof.

注: 上表仅为典型硬件配置. 如需了解详细情况, 请与我司联系. Note: The table only lists the typical hardware configuration. For more details, please contact us.

技术参数 Technical Parameters

额定电压: 220~240VAC, 短时最大过载电压 <264VAC/15min;

额定电压: 100~127VAC, 短时最大过载电压 <144VAC/15min

Rated voltage: 220~240VAC, Maximum overload voltage <264VAC/15min;

Rated voltage: 100~127VAC, Maximum overload voltage <144VAC/15min

整机功耗Consumption: ≤3W

测量范围Display range: -50~99°C/199°F

控温范围Control range: -50°C~99°C/199°F

测温精度Accuracy: -40~70°C, ≤±1°C; others, ≤±2°C

分辨率Resolution: -50~99.9°C/°F, 0.1; others, 1

产品尺寸Dimensions(mm): 76.5×35, 深度Depth = 61或60或44

安装尺寸Mounting(mm): 71×29

接线图 Wiring diagrams

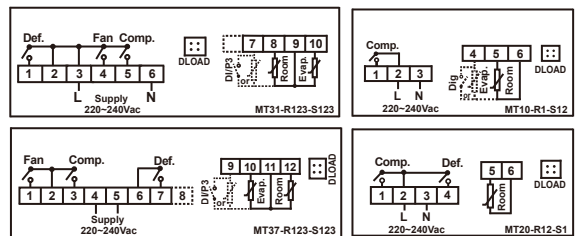

注: 更多接线图请翻阅详情表格.

Note: Please refer to the detailed table for more wiring diagrams.

用户参数表 User Menu Parameters For Other version, please contact us.

	Description	unit		Description	unit
PS	password	-	dC	Time base (for d/dP only; 0= h/min; 1= min/s)	-
/2	Measurement stability	-	A0	Alarm and fan differential (A0≤0: AL/AH as absolutes; A0>0: AL/AH as relative to the St)	°C/°F
/4	Select probe/input displayed(*)	-	AL	Absolute (-50=disable) or relative (0=disable) temperature for low temperature alarm	°C/°F
/5	Select °C/°F, 0=°C; 1=°F	-	AH	Absolute(250=disable) or relative(0=disable) temperature for high temperature alarm	°C/°F
/6	Disable decimal point, 1=disable	-	Ad	Low and high temperature alarm delay	Min
/C1	Probe 1 calibration	°C/°F		Digital input configuration(*)	
/C2	Probe 2 calibration (*)	°C/°F		0= not active; 1= exter. alarm, instant (A7= 0) or delayed (A7>0); 2= enable defrost (open=disabled); 3= start defrost on closing; 4= curtain switch or night-time operation (open= normal setpoint);	
/C3	Probe 3 calibration (*)	°C/°F	A4	5= remote ON/OFF (open= OFF); 6= AUX output control [H1=3] (open= AUX de-energ.);	-
St	Control temperature	°C/°F		7= AUX output [H1=3] + FAN OFF control (closed) (open= AUX energised);	
rd	Control differential (hysteresis)	°C/°F		8= AUX output [H1=3] + FAN-OFF (closed) + COMP-OFF control (closed); (open= AUX energised);	
r1	Minimum set point allowed to the user	°C/°F		9= select direct/reverse operation; 10= condenser probe; 11= product probe;	
r2	Maximum set point allowed to the user	°C/°F	A7	External alarm detection delay (*)	Min
r3	Operating mode 0= direct + defrost; 1= direct; 2= reverse	-	A8	Enable alarm 'Ed': end defrost by timeout (1= enabled) (*)	-
r4	Automatic night-time set point variation(*)	°C/°F	Ac	High condenser temperature alarm (*)	°C/°F
c0	Comp. and fan start delay after start-up	Min	AE	High condenser temperature alarm differential (*)	°C/°F
c1	Min. time between successive comp. starts	Min	AcD	High condenser temperature alarm delay (*)	Min
c2	Min. compressor off time	Min	F0	Fan management: (**)	-
c3	Min. compressor on time	Min		0= fans on excluding specific phases; 1= fans on according to parameter F1 excluding specific phases	
c4	Compressor safety (duty setting)	Min	F1	Fans shutdown temperature(**)	°C/°F
cc	Continuous cycle duration	Hr	F2	Fans off when compressor off (**)	-
c6	Alarm bypass time after cont. cycle	Hr	F3	Fans status during defrost: 0= fan ON; 1= fan OFF; (**)	-
d0	Defrost type: (0= heat; 1= hot gas; 2= heat by time; 3= hot gas by time; 4= heat by time with temp.	-	Fd	Off for post-dripping. Active for each val. of F0 (**)	Min
d1	Interval between two defrosts	Hr/min	H0	Serial address	-
dt	End defrost temperature set point/defrost temperature threshold with temp. control (*)	°C/°F		AUX output configuration,	
dP	Max. or effective defrost duration	Min/Se	H1	0=no function; 1=alarm NC output; 2=alarm NO output; 3=auxiliary output driven by dig. Input;	
d4	Defrost when the instrument is switched on (1= activated)	-		4=light output, Controlled by door or night curtain switch; 5= light output, Controlled by buttons	
d5	Defrost delay on start-up or from digital input	min	H2	Enable keypad: 0=keypad disabled, 1=keypad enabled, 2=keypad enabled except for ON/OFF	-
d6	Freeze temp. display during defrost (0="dP" alternating with temp., 1= freeze the display when defrost)	-	H4	Disable buzzer alarm: 0=buzzer enabled, 1=buzzer disabled	-
dd	Dripping time after defrost	Min		Relay configuration:	
d8	Alarm bypass time after defrost	Hr	H7	0=comp. + defrost+fan; 1=comp. +defrost+aux; 2=comp. +fan+aux; 3=comp. +defrost+none;	-
d9	Defrost priority over comp. protectors (0= protection time respected; 1= protection time not respected)	-		4=comp. +fan+none; 5=comp. +aux+none; 6=comp. +none+none;	
d/	Display defrost probe temp. (*)	°C/°F	EZY	Select Easy Set according to the model	-

LSKN系列-长条形 分体式控制器

LSKN series - Strip and split controller

LSKN100



可选择搭配控制盒型号信息 Optional control box

主型号	固件代码	压机继电器	端子规格	电网电压	外部接口	主板型号	继电器					传感器				防爆
Model	Firmware	Comp. relay	Terminal	Supply	Interface	Mainboard	R1	R2	R3	R4	R5	S1	S2	S3	S4	Explosion-proof
ThinkBoxN1	FW000F	H=2HP M=1HP L<=10A res.	V=NV connect F=Tab terminal	null=AC220...240 A=AC100...127 W=AC100~240 D=DC8...60	nul=TTL X=RS485	51=TB-P51	COMP.	DEF	FAN	LIGHT	DEFOG	RT	ET	DT	CT/PT	EX
						31=TB-P31	COMP.	DEF	FAN	/	/	RT	ET	DT	CT/PT	

注：上表仅为典型硬件配置，如需了解详细情况，请与我司联系。 Note: The table only lists the typical hardware configuration. For more details, please contact us.

技术参数 Technical Parameters

电源电压: 4.5~5.5VDC/ThinkBoxN1-FW000F控制盒提供
 Power Supply: 4.5~5.5VDC/ThinkBoxN1-FW000F Control Box supply
 整机功耗Consumption: ≤5W
 测量范围Display range: -50℃~99.9℃/199°F
 控温范围Control range: -50℃~99.9℃/F
 测温精度Accuracy: -40℃~70℃, ≤±1℃; others, ≤±2℃
 分辨率Resolution: -50~99.9℃/F, 0.1; others, 1
 ★需与ThinkBoxN1控制盒配合使用, LSKN100为主机, 控制盒为从机
 ★ThinkBoxN1 control box is required, LSKN100 works as the host, and the control box works as the slave
 产品尺寸Dimensions(mm): 180×32×18.8(深Depth)
 安装尺寸Mounting(mm): 173×26

接线图 Wiring diagrams

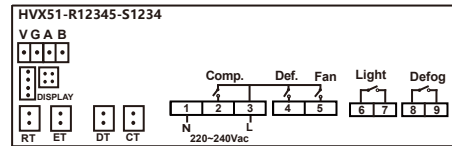

注：更多接线图请翻阅详情表格。
 Note: Please refer to the detailed table for more wiring diagrams.



参数表 Menu Parameters For Other version, please contact us.

	Description	Range	Unit
User Menu			
St	Set point	C4..C5	℃/F
Manager Menu			
PA	Manager menu password	0..99, master key=55	/
C1	Differential	0.1...50.0	℃/F
C2	Compressor start Min. interval	0..99	min
C3	Room probe calibration	-20.0...20.0	℃/F
C4	Minimum SetPoint	-50.0...St	℃/F
C5	Maximum SetPoint	St...99.9	℃/F
C6	Compressor initial start Min. interval	0..999	sec
d1	Defrost probe selection	0=disabled; 1=enable; 2=enable double defrost probe	/
d2	Interval between defrost cycle	0..99, 0=Defrost forbidden	hr
d3	Maximum length for defrost	1..99	min
d4	Display during defrost	0=real time temperature; 1=display 2=Room temperature when defrosts	/
d5	Room temperature display delay after defrost	0..99	min
d6	First defrosting interval after power on	10..999	min
d7	Defrost probe calibration	-20.0...20.0	℃/F
d8	Defrost termination temperature	-50.0...99.9	℃/F
d9	Dripping time after defrost	0..999	sec
d10	Defrost type	0=Electric; 1= Hot gas	/
d11	Defrost cycle calculation	0: cooling time; 1: natural time	/
d12	Time delay after defrost start	0..999, 0=cancel defrost start delay	sec
d13	Defrost at power-on	0=off; 1=on;	/
F1	Fans operating mode	0=runs with the compressor, OFF during defrost; 1=continuous mode, OFF during defrost; 2=runs with the compressor, ON during defrost; 3=continuous	/
F2	Fans delay after defrost	0..99	min
F3	Fans stop temperature	-50.0...99.9	℃/F
F4	Fan activation differential.	0.1...50.0	℃/F
F5	Fans on time if cooling off	0...250, 0=cancel proportional running	sec
F6	Fans off time if cooling off	1...999	min
A1	Compressor proportional on time with faulty	0..99	min
A2	Compressor proportional off time with faulty probe	0..99, 0=off	min
A3	Temperature alarm delay	0..999, 999=disable	min
A4	Temperature alarm delay at startup	0..999	min
A5	Temp. alarm delay time after defrost	0..999	min
A6	Temperature alarm upper deviation	0.1...50.0	℃/F
A7	Temperature alarm lower deviation	0.1...50.0	℃/F
A8	Alarm exit deviation	0.1...20.0	℃/F
A9	Display delay every 1℃/F change	0..999	sec
L1	Digital input polarity	0=disable; 1=close valid; 2=open	/
L2	Digital signal valid, sound alarm	0=off; 1=on	/
L3	Digital signal valid, fan output	0=off; 1=no effect	/
L4	Digital signal valid, sound alarm start delay	0..999	sec
L5	Fan restart delay after door open	0..199	sec
L6	Digital signal valid, delay off cooling	0..999, 0=disable off cooling	min
L7	deep cool mode start deviation(not with ECO)	0.1..40.0	℃/F
L8	deep cool mode stop deviation(not with ECO)	0.1..20.0	℃/F
L9	deep cool mode start detection time	0..999, 0=disable deep cool mode	min
L10	deep cool mode maximum working time	0.1..99.9	hour
L11	Door action count for start defrost	0..199, 0=disable to activate defrost	/
L12	Minimum cycle for door action to start defrost	1..999	min
L13	deep cool mode cycling continuous time	0..999	min
L14	deep cool mode cycling Setpoint	-50.0...99.9	℃/F
L15	deep cool mode cycling control differential	0.1..20.0	℃/F
Cd1	Condenser cleaning period	0.250, 0=cancel alarm	day
EC1	Enable ECO-DOOR mode	0=off; 1=on	/
EC2	Time to activate ECO mode	1..500	min
EC3	ECO mode differential	0.1...20.0	℃/F
EC4	Time to activate store closing mode	1..500	min
EC5	Store closing mode differential	0.1...20.0	℃/F
EC6	Number of actions to exit ECO mode	1..15	/
LC	Room temperature set point lock	0=lock; 1=unlock	/
P1	Set manager menu password	0..99, 0=cancel password	/
P5	Relay 2 load setting	0=Light; 1=defrost	/
P9	℃/F selection	0=°F; 1=°C	/
G1	Interval between defog cycle	0..999, 0=Disable auto on defogging; 999=disable defog function	min
Fq2	Auto defog time	0..999, 0=Disable auto off defogging	min

有背景指示的触摸面板

Keepthink Touch Panel

SSTN100系列-分体式控制器

SSTN series - Split type controller

SSTN100



可选择搭配控制盒型号信息 Optional control box

主型号 Model	固件代码 Firmware	压机继电器 Comp. relay	端子规格 Terminal	电网电压 Supply	外部接口 Interface	主板型号 Mainboard	继电器 R1 R2 R3 R4 R5					传感器 S1 S2 S3 S4				防爆 Explosion-proof
ThinkBoxN1	FW000F	H=2HP M=1HP L<=10A res.	V=NV connect F=Tab terminal	null=AC220...240 A=AC100...127 W=AC100~240 D=DC8...60	null=TTL X=RS485	51=TB-P51 31=TB-P31	COMP.	DEF	FAN	LIGHT	DEFOG	RT	ET	DT	CT/PT	EX

注：上表仅为典型硬件配置。如需了解详细情况，请与我司联系。 Note: The table only lists the typical hardware configuration. For more details, please contact us.

技术参数 Technical Parameters

电源电压：4.5~5.5VDC/ThinkBoxN1-FW000F控制盒提供

Power Supply: 4.5~5.5VDC/ThinkBoxN1-FW000F Control Box supply

整机功耗Consumption: ≤5W

测量范围Display range: -50°C~99.9°C/199°F

控温范围Control range: -50°C~99.9°C/°F

测温精度Accuracy: -40°C~70°C, ≤±1°C; others, ≤±2°C

分辨率Resolution: -50~99.9°C/°F, 0.1; others, 1

★需与ThinkBoxN1控制盒配合使用, SSTN100为主机, 控制盒为从机

★ThinkBoxN1 control box is required, SSTN100 works as the host, and the control box works as the slave

产品尺寸Dimensions(mm): 180×32×18.8(深Depth)

安装尺寸Mounting(mm): 173×26

接线图 Wiring diagrams

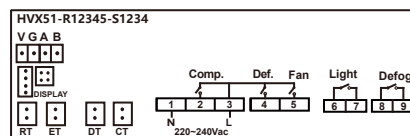

注：更多接线图请翻阅详情表格。

Note: Please refer to the detailed table for more wiring diagrams.



参数表 Menu Parameters For Other version, please contact us.

	Description	Range	Unit
User Menu			
St	Set point	C4...C5	°C/°F
Manager Menu			
PA	Manager menu password	0...99, master key=55	/
C1	Differential	0.1...50.0	°C/°F
C2	Compressor start Min. interval	0...99	min
C3	Room probe calibration	-20.0...20.0	°C/°F
C4	Minimum SetPoint	-50.0...St	°C/°F
C5	Maximum SetPoint	St...99.9	°C/°F
C6	Compressor initial start Min. interval	0...999	sec
d1	Defrost probe selection	0=disabled; 1=enable; 2=enable double defrost probe	/
d2	Interval between defrost cycle	0...99, 0=Defrost forbidden	hr
d3	Maximum length for defrost	1...99	min
d4	Display during defrost	0=real time temperature; 1=display 2=Room temperature when defrosts	/
d5	Room temperature display delay after defrost	0...99	min
d6	First defrosting interval after power on	10...999	min
d7	Defrost probe calibration	-20.0...20.0	°C/°F
d8	Defrost termination temperature	-50.0...99.9	°C/°F
d9	Dripping time after defrost	0...999	sec
d10	Defrost type	0=Electric; 1= Hot gas	/
d11	Defrost cycle calculation	0: cooling time; 1: natural time	/
d12	Time delay after defrost start	0...999, 0=cancel defrost start delay	sec
d13	Defrost at power-on	0=off; 1=on;	/
F1	Fans operating mode	0=runs with the compressor, OFF during defrost; 1=continuous mode, OFF during defrost; 2=runs with the compressor, ON during defrost; 3=continuous	/
F2	Fans delay after defrost	0...99	min
F3	Fans stop temperature	-50.0...99.9	°C/°F
F4	Fan activation differential.	0.1...50.0	°C/°F
F5	Fans on time if cooling off	0...250, 0=cancel proportional running	sec
F6	Fans off time if cooling off	1...999	min
A1	Compressor proportional on time with faulty	0...99	min
A2	Compressor proportional off time with faulty probe	0...99, 0=off	min
A3	Temperature alarm delay	0...999, 999=disable	min
A4	Temperature alarm delay at startup	0...999	min
A5	Temp. alarm delay time after defrost	0...999	min
A6	Temperature alarm upper deviation	0.1...50.0	°C/°F
A7	Temperature alarm lower deviation	0.1...50.0	°C/°F
A8	Alarm exit deviation	0.1...20.0	°C/°F
A9	Display delay every 1°C/°F change	0...999	sec
L1	Digital input polarity	0=disable; 1=close valid; 2=open	/
L2	Digital signal valid sound alarm	0=off; 1=on	/
L3	Digital signal valid fan output	0=off; 1=no effect	/
L4	Digital signal valid sound alarm start delay	0...999	sec
L5	Fan restart delay after door open	0...199	sec
L6	Digital signal valid, delay off cooling	0...999, 0=disable off cooling	min
L7	deep cool mode start deviation(not with ECO)	0.1...40.0	°C/°F
L8	deep cool mode stop deviation(not with ECO)	0.1...20.0	°C/°F
L9	deep cool mode start detection time	0...999, 0=disable deep cool mode	min
L10	deep cool mode maximum working time	0.1...99.9	hour
L11	Door action count for start defrost	0...199, 0=disable to activate defrost	/
L12	Minimum cycle for door action to start defrost	1...999	min
L13	deep cool mode cycling continuous time	0...999	min
L14	deep cool mode cycling Setpoint	-50.0...99.9	°C/°F
L15	deep cool mode cycling control differential	0.1...20.0	°C/°F
Cd1	Condenser cleaning period	0...250, 0=cancel alarm	day
EC1	Enable ECO-DOOR mode	0=off; 1=on	/
EC2	Time to activate ECO mode	1...500	min
EC3	ECO mode differential	0.1...20.0	°C/°F
EC4	Time to activate store closing mode	1...500	min
EC5	Store closing mode differential	0.1...20.0	°C/°F
EC6	Number of actions to exit ECO mode	1...15	/
LC	Room temperature set point lock	0=lock; 1=unlock	/
P1	Set manager menu password	0...99, 0=cancel password	/
P5	Relay 2 load setting	0=Light; 1=defrost	/
P9	°C/°F selection	0=°F; 1=°C	/
Fg1	Interval between defog cycle	0...999, 0=Disable auto on defogging; 999=disable defog function	min
Fg2	Auto defog time	0...999, 0=Disable auto off defogging	min

KeepThink

创新，源于持续的思考和行动

LW-1000系列 - 商超及便利店通用温度控制器 LW-1000 series - Supermarket Controller

LW-1000



产品型号信息 Model Info

产品系列 Model	软件型号 Software	压机继电器 Comp. relay	端子规格 Terminal	电网电压 Supply	主板型号 Mainboard	继电器 Relay					蜂鸣音 Buzzer	显示表 Panel	内部标识 Mark	传感器 Sensor			防爆 Explosion-proof
						R1	R2	R3	R4	R5				S1	S2	S3	
LW1000	null N1...N99	H=2HP M=1HP L<=10A res.	V=NV Bar connect	null=AC220...240 A=AC100...127 W=AC100~240 D=DC8...60	31=LW1K-P31 S1=LW1K-P51	COMP.	DEF	FAN	LIGHT	DEFOG	B	P	E	RT	ET	DT	EX

例: LW1000N1-HV-R12345-S123-EX, H=2HP COMPRESSOR, V=NV Bar connect, R1=compressor relay, R2=defrost relay, R3=fan relay, R4=light relay, R5=defog relay, S1=room probe, S2=defrost probe, S3=Dig probe, EX=explosion-proof.

注: 上表仅为典型硬件配置. 如需了解详细情况, 请与我司联系. Note: The table only lists the typical hardware configuration. For more details, please contact us.

技术参数 Technical Parameters

额定电压: 220~240VAC, 短时最大过载电压 <264VAC/15min;
 额定电压: 100~127VAC, 短时最大过载电压 <144VAC/15min
 Rated voltage: 220~240VAC, Maximum overload voltage <264VAC/15min;
 Rated voltage: 100~127VAC, Maximum overload voltage <144VAC/15min
 整机功耗 Consumption: ≤5W
 测量范围 Display range: -50~99.9°C/199°F
 控温范围 Control range: -50~99.9°C/°F
 测温精度 Accuracy: -40~70°C, ±1°C; others, ±2°C
 分辨率 Resolution: -50~99.9°C/°F, 0.1; others, 1
 产品尺寸 Dimensions(mm): 147×42×48(深Depth)
 安装尺寸 Mounting(mm): 138×32.5

接线图 Wiring diagrams

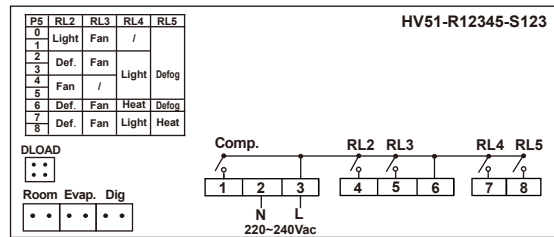

注: 更多接线图请翻阅详情表格.
 Note: Please refer to the detailed table for more wiring diagrams.

参数表 Menu Parameters For Other version, please contact us.

Men	Description	Range	Unit
User Menu			
S1	Temperature SetPoint	C4...C5	°C/°F
Management Menu			
PA	Manager menu password	0...99, master key=55	/
C1	Differential	0.1...50.0	°C/°F
C2	Compressor start minimum interval	0...99	min
C3	Room probe calibration	-20.0...20.0	°C/°F
C4	Minimum SetPoint	50.0...St	°C/°F
C5	Maximum SetPoint	St...99.9	°C/°F
C6	Compressor initial start minimum interval	0...999	sec
d1	Defrost probe selection	0=disable; 1=enable; 2=double defrost probe	/
d2	Defrost cycle	0...99, 0=Defrost forbidden	hr
d3	Maximum defrosting time	1...99	min
d4	Display lock during defrost	0= room temperature; 1=dEF; 2=Room temperature when defrosts starts;	/
d5	Room temperature display delay after defrost	0...99	min
d6	First defrosting interval after power on	10...999	min
d7	Defrost probe calibration	-20.0...20.0	°C/°F
d8	Defrost stop temperature	50.0...99.9	°C/°F
d9	Dripping time after defrost	0...999	sec
d10	Defrost type	0=Electric; 1= Hot gas	/
d11	Defrost cycle calculation	0: cooling time; 1: natural time	/
d12	Defrost start output delay	0...999, 0=cancel defrost delay	sec
d13	Defrost at power-on	0=off; 1=on;	/
F1	Fan running mode	0=same with the compressor, OFF during defrost;	/
F2	Fan start delay after defrost	0...99	min
F3	Fan stop temperature	50.0...99.9	°C/°F
F4	Fan activation differential	0.1...50.0	°C/°F
F5	Fan proportional on time if cool off	0...250, 0=off proportional running	sec
F6	Fan proportional off time if cool off	1...999	min
A1	Cooling proportional off time if probe fails	0...99	min
A2	Cooling proportional on time if probe fails	0...99, 0=continuously off	min
A3	Temperature alarm delay	0...999, 999=disable	min
A4	Temperature alarm delay at power-on	0...999	min
A5	Temperature alarm delay after defrost	0...999	min
A6	Temperature alarm upper differential	0.1...50.0	°C/°F
A7	Temperature alarm lower differential	0.1...50.0	°C/°F
A8	Alarm exit differential	0.1...20.0	°C/°F

A9	Display delay of 1°C/°F increasing	0...999	sec
L1	Digital input polarity	0=disable and; 1=close valid; 2=open valid	/
L2	Digital signal valid, sound alarm output	0=off; 1=on	/
L3	Digital signal valid, fan output	0=off; 1=not effect	/
L4	Digital signal valid, sound alarm delay	0...999	sec
L5	Restart delay after door open and fan off	0...199	sec
L6	Digital signal valid, cooling stop delay	0...999, 0=disable off cooling	min
L7	deep cool mode start deviation(not with ECO)	0.1...40.0	°C/°F
L8	deep cool mode stop deviation(not with ECO)	0.1...20.0	°C/°F
L9	deep cool mode start detection time	0...999, 0=disable deep cool mode	min
L10	deep cool mode maximum working time	0.1...99.9	hr
L11	Door action count for start defrost	0...199, 0=disable start defrost	/
L12	Minimum cycle for door action to start	1...999	min
L13	deep cool mode cycling continuous time	0...999	min
L14	deep cool mode cycling Setpoint	50.0...99.9	°C/°F
L15	deep cool mode cycling control differential	0.1...20.0	°C/°F
Cd1	Condenser cleaning period	0...250, 0=cancel alarm	day
EC1	Enable ECO-DOOR mode	0=no; 1=yes	/
EC2	Time to activate ECO mode	1...500	min
EC3	Temperature differential of ECO mode	0.1...20.0	°C/°F
EC4	Time to activate Store Closing Mode	1...500	min
EC5	Temperature differential in store close mode	0.1...20.0	°C/°F
EC6	Number of actions to exit ECO mode	1...15	/
LC	Room temperature set point lock	0=lock; 1=unlock	/
P1	Set manager menu password	0...99, 0=not password	/
P5	relay function set	0: RL2=button light, RL3=fan, RL4=not, RL5=defog; 1: RL2=door light, RL3=fan, RL4=not, RL5=defog; 2: RL2=defrost, RL3=fan, RL4=button light, RL5=defog; 3: RL2=defrost, RL3=fan, RL4=door light, RL5=defog; 4: RL2=fan, RL3=not, RL4=button light, RL5=defog; 5: RL2=fan, RL3=not, RL4=door light, RL5=defog; 6: RL2=defrost, RL3=fan, RL4=waterheat, RL5=defog; 7: RL2=defrost, RL3=fan, RL4=button light, 8: RL2=defrost, RL3=fan, RL4=door light,	/
P9	°C/°F selection	0=°F; 1=°C	/
H1	WaterBox heating delay time	0...999	sec
Fg1	Interval between defog cycle	0...999, 0=Disable auto defog on; 99= Cancel	min
Fg2	Maximum defog time	0...999, 0=Disable auto defog off	min
Fg3	Auto defog temperature point	50.0...99.9, 99.9=Cancel	°C/°F

可8-48vac/60vdc供电的冷藏车控制器

A refrigerated van controller powered by 8-48vac/60vdc

AB2300/ABU3300



产品型号信息 Model Info

产品系列 Model	软件型号 Software	压机继电器 Comp. relay	端子型号 Terminal	电网电压 Supply	主板型号 Mainboard	继电器 Relay				蜂鸣器 Buzzer	显示表 Panel	内部标识 Mark	传感器 Sensor			塑料壳 Plastic shell	防爆 Explosion-proof	
						R1	R2	R3	SPDT				S1	S2	S3			
AB2300	null N1...N99	H=2HP M=1HP L<=10A res.	T=Screw terminal V=NV Bar connect R=Plug terminal F=Tab terminal	null=AC220...240 A=AC100...127 W=AC100-240 D=DC8...60	10=AB-P10 20=AB-P20 23=AB-P23 31=AB-P31 35=AB-P35 37=AB-P37 41=AB-P41 44=AB-P44	COMP.	DEF	FAN	/	P23/35: Z=R1Z P37: Z=R2Z P44: Z=R1Z	B	P	E	RT	ET	DT	BK=Black shell BU=Blue shell BK1-BK99 BU1-BU99	EX
ABU3300																		

例: AB2300-MTD37-R1-S1-BK-EX, M=1HP COMPRESSOR, T=Screw terminal, D=DC8...60 supply, 37=PCB model, R1=compressor relay, S1=room probe, BK=Black shell, EX=explosion-proof.

注: 上表仅为典型硬件配置, 如需了解详细情况, 请与我司联系。Note: The table only lists the typical hardware configuration. For more details, please contact us.

技术参数 Technical Parameters

额定电压: 8~60VDC, 短时最低电压: 7VDC/15min;

Rated voltage: 8~60VDC, Minimum Short-term voltage: 7VDC/15min;

整机功耗Consumption: ≤3W

测量范围Display range: -50°C~99.9°C/199°F

控温范围Control range: -50°C~99.9°C/°F

测温精度Accuracy: -40~70°C, ±1°C; others, ±2°C

分辨率Resolution: -50~99.9°C/°F, 0.1; others, 1

产品尺寸Dimensions(mm): 76.5×35, 深度Depth =61

安装尺寸Mounting(mm): 71×29

接线图 Wiring diagrams

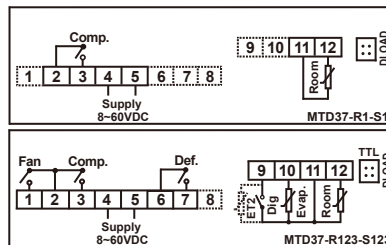

注: 更多接线图请翻阅详情表格。

Note: Please refer to the detailed table for more wiring diagrams.

参数表 Menu Parameters For Other version, please contact us.

Description		Range	Unit
User Menu			
St	Temperature SetPoint	C4...C5	°C/°F
Management Menu			
PA	Manager menu password	0...99, master key=55	/
C1	Differential	0.1...50.0	°C/°F
C2	Compressor start minimum interval	0...99	min
C3	Room probe calibration	-20.0...20.0	°C/°F
C4	Minimum SetPoint	-50.0...St	°C/°F
C5	Maximum SetPoint	St...99.9	°C/°F
C6	Compressor initial start minimum interval	0...999	sec
d1	defrost probe selection	0=disable; 1=enable; 2=enable double defrost probe	/
d2	Defrost cycle	0...99, 0=Defrost forbidden	hr
d3	Maximum defrosting time	1...99	min
d4	Display lock during defrost	0= room temperature; 1=dEF; 2=Room temperature when defrosts starts,	/
d5	Room temperature display delay after defrost	0...99	min
d12	First defrosting interval after power on	10...999	min
d7	Defrost probe calibration	-20.0...20.0	°C/°F
d8	Defrost stop temperature	-50.0...99.9	°C/°F
d9	Dripping time after defrost	0...999	sec
d10	Defrost type	0=Electric; 1= Hot gas	/
d11	Defrost cycle calculation	0: cooling time; 1: natural time	/
d12	Defrost start output delay	0...999, 0=cancel defrost delay	sec
d13	Defrost at power-on	0=off; 1=on;	/
F1	Fan running mode	0=same with the compressor, OFF during	/
F2	Fan start delay after defrost	0...99	min
F3	Fan stop temperature	-50.0...99.9	°C/°F
F4	Fan activation differential	0.1...50.0	°C/°F
F5	Fan proportional on time if cool off	0...250, 0=off proportional running	sec
F6	Fan proportional off time if cool off	1...999	min
A1	Cooling proportional off time if probe fails	0...99	min
A2	Cooling proportional on time if probe fails	0...99, 0=continuously off	min
A3	Temperature alarm delay	0...999, 999=disable	min

A4	Temperature alarm delay at power-on	0...999	min
A5	Temperature alarm delay after defrost	0...999	min
A6	Temperature alarm upper differential	0.1...50.0	°C/°F
A7	Temperature alarm lower differential	0.1...50.0	°C/°F
A8	Alarm exit differential	0.1...20.0	°C/°F
A9	Display delay of 1°C/°F increasing	0...999	sec
L1	Digital input polarity	0=disable and; 1=close valid; 2=open valid	/
L2	Digital signal valid, sound alarm output	0=off; 1=on	/
L3	Digital signal valid, Fan output	0=off; 1=not effect	/
L4	Digital signal valid, sound alarm delay	0...999	sec
L5	Restart delay after door open and fan off	0...199	sec
L6	Digital signal valid, cooling stop delay	0...999, 0=disable off cooling	min
L7	deep cool mode start deviation(not with ECO)	0.1...40.0	°C/°F
L8	deep cool mode stop deviation(not with ECO)	0.1...20.0	°C/°F
L9	deep cool mode start detection time	0...999, 0=disable deep cool mode	min
L10	deep cool mode maximum working time	0.1...99.9	hr
L11	Door action count for start defrost	0...199, 0=disable start defrost	/
L12	Minimum cycle for door action to start defrost	1...999	min
L13	deep cool mode cycling continuous time	0...999	min
EC1	Enable ECO-DOOR mode	0=no; 1=yes	/
EC2	Time to activate ECO mode	1...500	min
EC3	Temperature differential of ECO mode	0.1...20.0	°C/°F
EC4	Time to activate Store Closing Mode	1...500	min
EC5	Temperature differential in store close mode	0.1...20.0	°C/°F
EC6	Number of actions to exit ECO mode	1...15	/
LC	Room temperature set point lock	0=lock; 1=unlock	/
P1	Set manager menu password	0...99, 0=not password	/
P5	Second relay function set	0=Light, Light is related to keys 1=Defrost, Light is related to keys 2=Light, Light is related to digital signal; 3=Defrost, Light is related to digital signal;	/
P9	°C/°F selection	0=°F; 1=°C	/
AdU	Upload data interval (ABU series valid)	0...120, 0=disable	sec
Adr	Controller address (ABU series valid)	1...255	/

MSKN系列-大面板 分体式控制器 MSKN series - Large panel, split controller



MSKN100

MSKN100N1



支持插针传感器
support insert probe

MSKN100/100N1

风冷式控制 Air cooling control



可选择搭配控制盒型号信息 Optional control box

主型号	固件代码	压机继电器	端子规格	电网电压	外部接口	主板型号	继电器					传感器				防爆
Model	Firmware	Comp. relay	Terminal	Supply	Interface	Mainboard	R1	R2	R3	R4	R5	S1	S2	S3	S4	Explosion-proof
ThinkBoxN1	FW000F	H=2HP M=1HP L<=10A res.	V=NV connect F=Tab terminal	null=AC220...240 A=AC100...127 W=AC100~240 D=DC8...60	nul=TTL X=RS485	51=TB-P51	COMP.	DEF	FAN	LIGHT	DEFOG	RT	ET	DT	CT/PT	EX
						31=TB-P31	COMP.	DEF	FAN	/	/	RT	ET	DT	CT/PT	

注：上表仅为典型硬件配置，如需了解详细情况，请与我司联系。 Note: The table only lists the typical hardware configuration. For more details, please contact us.

技术参数 Technical Parameters

电源电压: 4.5~5.5VDC/ThinkBoxN1-FW000F控制盒提供
Power Supply: 4.5~5.5VDC/ThinkBoxN1-FW000F Control Box supply
整机功耗Consumption: ≤5W
测量范围Display range: -50°C~99.9°C/199°F
控温范围Control range: -50°C~99.9°C/°F
测温精度Accuracy: -40°C~70°C, ±1°C; others, ±2°C
分辨率Resolution: -50~99.9°C/°F, 0.1; others, 1
★需与ThinkBoxN1控制盒配合使用, MSKN100为主机, 控制盒为从机
★ThinkBoxN1 control box is required, MSKN100 works as the host, and the control box works as the slave
产品尺寸Dimensions(mm): 180×32×18.8(深Depth)
安装尺寸Mounting(mm): 173×26

接线图 Wiring diagrams

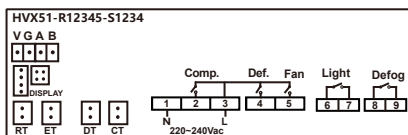

注：更多接线图请参阅详情表格。
Note: Please refer to the detailed table for more wiring diagrams.

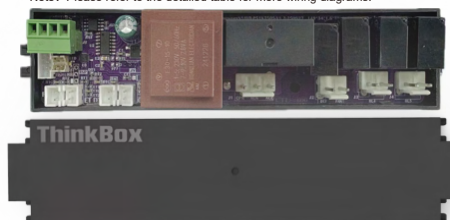

参数表 Menu Parameters For Other version, please contact us.

	Description	Range	Unit
User Menu			
St	Set point	C4...C5	°C/°F
Manager Menu			
PA	Manager menu password	0..99, master key=55	/
C1	Differential	0.1...50.0	°C/°F
C2	Compressor start Min. interval	0..99	min
C3	Room probe calibration	-20.0...20.0	°C/°F
C4	Minimum SetPoint	-50.0...St	°C/°F
C5	Maximum SetPoint	St...99.9	°C/°F
C6	Compressor initial start Min. interval	0..999	sec
d1	Defrost probe selection	0=disabled; 1=enable; 2=enable double defrost probe	/
d2	Interval between defrost cycle	0..99, 0=Defrost forbidden	hr
d3	Maximum length for defrost	1..99	min
d4	Display during defrost	0=real time temperature; 1=display 2=Room temperature when defrosts	/
d5	Room temperature display delay after defrost	0..99	min
d6	First defrosting interval after power on	10...999	min
d7	Defrost probe calibration	-20.0...20.0	°C/°F
d8	Defrost termination temperature	-50.0...99.9	°C/°F
d9	Dripping time after defrost	0..999	sec
d10	Defrost type	0=Electric; 1= Hot gas	/
d11	Defrost cycle calculation	0:cooling time; 1:natural time	/
d12	Time delay after defrost start	0..999,0=cancel defrost start delay	sec
d13	Defrost at power-on	0=off; 1=on;	/
F1	Fans operating mode	0=runs with the compressor, OFF during defrost; 1=continuous mode, OFF during defrost; 2=runs with the compressor, ON during defrost; 3=continuous	/
F2	Fans delay after defrost	0..99	min
F3	Fans stop temperature	-50.0...99.9	°C/°F
F4	Fan activation differential.	0.1...50.0	°C/°F
F5	Fans on time if cooling off	0..250, 0=cancel proportional running	sec
F6	Fans off time if cooling off	1...999	min
A1	Compressor proportional on time with faulty	0..99	min
A2	Compressor proportional off time with faulty probe	0..99, 0=off	min
A3	Temperature alarm delay	0..999, 999=disable	min
A4	Temperature alarm delay at startup	0..999	min
A5	Temp. alarm delay time after defrost	0..999	min
A6	Temperature alarm upper deviation	0.1...50.0	°C/°F
A7	Temperature alarm lower deviation	0.1...50.0	°C/°F
A8	Alarm exit deviation	0.1... 20.0	°C/°F
A9	Display delay every 1°C/°F change	0..999	sec
L1	Digital input polarity	0=disable; 1=close valid; 2=open	/
L2	Digital signal valid,sound alarm	0=off; 1=on	/
L3	Digital signal valid,fan output	0=off; 1=no effect	/
L4	Digital signal valid,sound alarm start delay	0..999	sec
L5	Fan restart delay after door open	0..199	sec
L6	Digital signal valid,delay off cooling	0..999, 0=disable off cooling	min
L7	deep cool mode start deviation(not with ECO)	0.1...40.0	°C/°F
L8	deep cool mode stop deviation(not with ECO)	0.1... 20.0	°C/°F
L9	deep cool mode start detection time	0..999, 0=disable deep cool mode	min
L10	deep cool mode maximum working time	0.1..99.9	hour
L11	Door action count for start defrost	0..199,0=disable to activate defrost	/
L12	Minimum cycle for door action to start defrost	1..999	min
L13	deep cool mode cycling continuous time	0..999	min
L14	deep cool mode cycling Setpoint	-50.0...99.9	°C/°F
L15	deep cool mode cycling control differential	0.1...20.0	°C/°F
Cd1	Condenser cleaning period	0..250,0=cancel alarm	day
EC1	Enable ECO-DOOR mode	0=off; 1=on	/
EC2	Time to activate ECO mode	1..500	min
EC3	ECO mode differential	0.1...20.0	°C/°F
EC4	Time to activate store closing mode	1..500	min
EC5	Store closing mode differential	0.1...20.0	°C/°F
EC6	Number of actions to exit ECO mode	1..15	/
LC	Room temperature set point lock	0=lock; 1=unlock	/
P1	Set manager menu password	0..99, 0=cancel password	/
P5	Relay 2 load setting	0=Light; 1=defrost	/
P9	°C/°F selection	0=°F; 1=°C	/
Fg1	Interval between defog cycle	0..999, 0=Disable auto on defogging; 999=disable defog function	min
Fg2	Auto defog time	0..999, 0=Disable auto off defogging	min

MSKN系列-大面板 分体式控制器

MSKN series - Large panel, split controller

MSKN201 直冷单温控制 Single temp. zone Control

MSKN202 直冷双温控制 Double temp. zone Control

制冷1
Cooling1制冷2
Cooling2除霜1
Defrost1除霜2
Defrost2灯光
Light测量单位
°C/°F探头≤2
Probes2电源控制
Standby数据笔
DLOAD调节0.1
Adjust 0.1

可选择搭配控制盒型号信息 Optional control box

主型号 Model	固件代码 Firmware	压机继电器 Comp. relay	端子规格 Terminal	电网电压 Supply	外部接口 Interface	主板型号 Mainboard	继电器 R1 R2 R3			传感器 S1 S2		防爆 Explosion-proof
MSKN201 ThinkBoxN1	FW0010	H=2HP M=1HP	V=NV connect	null=AC220...240 A=AC100...127	null=TTL X=RS485	31=TB-P31	COMP.	/	LIGHT	RT	/	EX
MSKN202 ThinkBoxN1	FW0011	L<=10A res.	F=Tab terminal	W=AC100~240 D=DC8...60			COMP.1	COMP.2	LIGHT	RT1	RT2	

注：上表仅为典型硬件配置，如需了解详细情况，请与我司联系。Note: The table only lists the typical hardware configuration. For more details, please contact us.

技术参数 Technical Parameters

电源电压：4.5~5.5VDC/ThinkBoxN1-FW0010控制盒提供
Power Supply: 4.5~5.5VDC/ThinkBoxN1-FW0010 Control Box supply
整机功耗Consumption: ≤5W

测量范围Display range: -50°C~99.9°C/199°F

控温范围Control range: -50°C~99.9°C/199°F

测温精度Accuracy: -40°C~70°C, ±1°C; others, ±2°C

分辨率Resolution: -50~99.9°C/°F, 0.1; others, 1

★需与ThinkBoxN1控制盒配合使用，MSKN201/202为主机，控制盒为从机
★ThinkBoxN1 control box is required, MSKN201/202 works as the host, and the control box works as the slave

产品尺寸Dimensions: 170×58×21(深Depth)

安装尺寸Mounting(mm): 162×50

接线图 Wiring diagrams

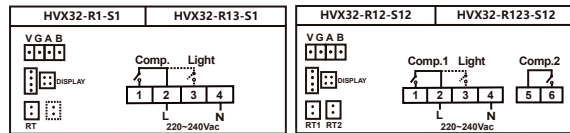

注：更多接线图请翻阅详情表格。

Note: Please refer to the detailed table for more wiring diagrams.

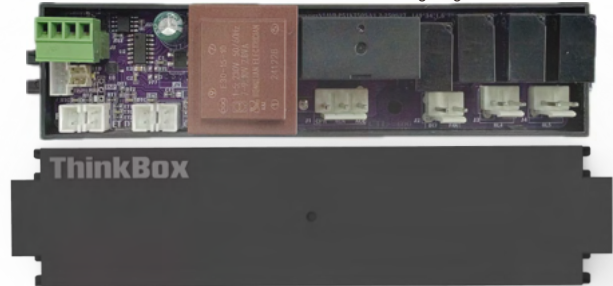

参数表 Menu Parameters For Other version, please contact us.

Parameters for MSKN201:			
Menu	Description	Range	Unit
St	Set point 1	C4...C5	°C/°F
Manager Menu			
PA	Manager menu password	0...99, master key=55	/
C1	Differential	1.0...50.0	°C/°F
C2	Compressor start Min. interval	0...99	min
C3	Room probe calibration	-20.0...20.0	°C/°F
C4	Minimum SetPoint	-50.0...St	°C/°F
C5	Maximum SetPoint	St...99.9	°C/°F
C6	Compressor initial start Min. interval	0...999	sec
d2	Interval between defrost cycle	0...99, 0=Defrost forbidden	hr
d3	Maximum length for defrost	1...99	min
d4	Display during defrost	0= room temperature; 1=display dEF;	/
A1	Compressor on time with faulty probe	0...99, 0=on	min
A2	Compressor off time with faulty probe	0...99, 0=off	min
A9	Display delay every 1°C/°F change	0...999	sec
P1	Set manager menu password	0...99, 0=cancel password	/
P9	°C/°F selection	0=°F; 1=°C	/

Parameters for MSKN202:			
Menu	Description	Range	Unit
St2	Set point 2	2C4...2C5	°C/°F
2C1	Differential	1.0...50.0	°C/°F
2C2	Compressor start Min. interval	0...99	min
2C3	Room probe calibration	-20.0...20.0	°C/°F
2C4	Minimum SetPoint	-50.0...St	°C/°F
2C5	Maximum SetPoint	St...99.9	°C/°F
2C6	Compressor initial start Min. interval	0...999	sec
2d2	Interval between defrost cycle	0...99, 0=Defrost forbidden	hr
2d3	Maximum length for defrost	1...99	min
2d4	Display during defrost	0= room temperature; 1=display dEF;	/
2A1	Compressor on time with faulty probe	0...99, 0=on	min
2A2	Compressor off time with faulty probe	0...99, 0=off	min
2A9	Display delay every 1°C/°F change	0...999	sec

大面板 分体式控制器

Large panel, split controller

ODMA1

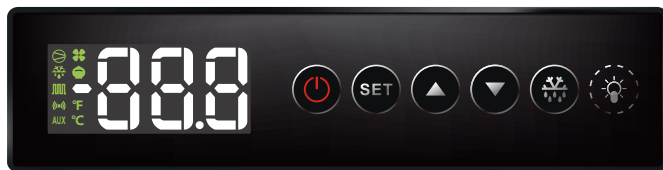

可选择搭配控制盒型号信息 Optional control box

主型号	固件代码	压机继电器	端子规格	电网电压	外部接口	主板型号	继电器					传感器				防爆
Model	Firmware	Comp. relay	Terminal	Supply	Interface	Mainboard	R1	R2	R3	R4	R5	S1	S2	S3	S4	Explosion-proof
ThinkBoxN1	FWxxxx	H=2HP M=1HP L<=10A res.	V=NV connect F=Tab terminal	null=AC220...240 A=AC100...127 W=AC100~240 D=DC8...60	nul=TTL X=RS485	51=TB-P51	COMP.	DEF	FAN	LIGHT	DEFOG	RT	ET	DT	CT/PT	EX
						31=TB-P31	COMP.	DEF	FAN	/	/	RT	ET	DT	CT/PT	

注：上表仅为典型硬件配置，如需了解详细情况，请与我司联系。 Note: The table only lists the typical hardware configuration. For more details, please contact us.

技术参数 Technical Parameters

额定电压：220~240VAC, 短时最大过载电压<264VAC/15min
 Rated voltage: 220~240VAC, Maximum overload voltage<264VAC/15min
 整机功耗Consumption: ≤5W
 测量范围Display range: -50°C~99.9°C/-58°F~210°F
 控温范围Control range: -50°C~99°C/°F
 测温精度Accuracy: -40~70°C, ≤±1°C; others, ≤±2°C
 分辨率Resolution: 0.1°C/1°F
 电源板尺寸Power board dimensions(mm): 114.5×56
 操作板尺寸Handle dimensions (mm): 205×55×23(深Depth)
 操作板安装尺寸Handle mounting(mm): 199×51

接线图 Wiring diagrams

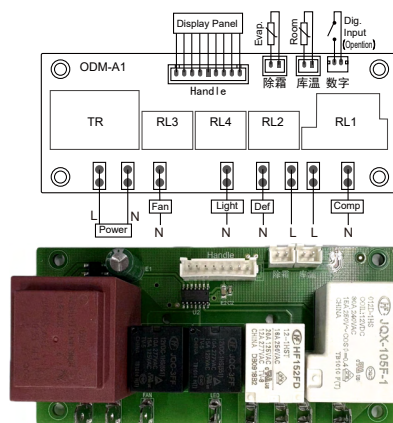

参数表 Menu Parameters For Other version, please contact us.

Menu	Description	Range	Unit
St	Setpoint	LS...US	°C/°F
Hy	Differential	0.1°C...10.0°C/1°F...20°F	°C/°F
LS	Minimum SetPoint	-50...St	°C/°F
US	Maximum SetPoint	St...99	°C/°F
ot	Room probe calibration	-9.9°C...9.9°C/-20°F...20°F	°C/°F
P2	Evap. probe on/off	y=on; n=off	-
oE	Evap. probe calibration	-9.9°C...9.9°C/-20°F...20°F	°C/°F
od	Outputs activation delay at start up	0...99	min
AC	Anti-short cycle delay	0...99	min
Cy	Compressor ON time faulty probe	0...99	min
Cn	Compressor OFF time faulty probe	0...99	min
CF	Measurement units	C=Centigrade; F=Fahrenheit	-
Ld	Default Display	P1=Room probe; P2=Defrost probe	-
dy	Display delay	00...20	min
td	Defrost type	EL=Electric; in= Hot gas	-
dE	Defrost termination temp.	-50...90	°C/°F
id	Interval between defrost cycles	0...99	hour
Md	Maximum length for defrost	1...99	min
dd	Start defrost delay	0...99	min
dF	Display during defrost	rt= real temperature; St=setpoint dF=label dF; it= start defrost temp.	-
dt	Drip time	0...99	min

dP	Defrost at power-on	y=on; n=off	-
FC	Fans operating mode	Cn= runs with the compressor, OFF during defrost;	-
		Cy=runs with the compressor, ON during defrost; on= continuous mode, OFF during defrost; oy=continuous mode, On during defrost	-
Fd	Fans delay after defrost	0...99	min
FS	Fans stop temperature	-50...90	°C/°F
AU	Maximum temperature alarm	(AL+1)...99	°C/°F
AL	Minimum temperature alarm	-50...(AU-1)	°C/°F
Ad	Temperature alarm delay	0...99	min
dA	Exclusion of temp. alarm at startup	0...99	min
iP	Digital input polarity	oP= activated by closing the contact	-
		CL=activated by opening the contact	-
iF	Digital input configuration	EA=external alarm, Display EA message;	-
		bA=serious alarm, Display CA message;	-
		do=door switch, Display DA message;	-
		dF= defrost activation; AU=not used; HC=not used;	-
di	Digital input delay	0~99min	min
dC	Compressor and fan status when open door	no= normal;	-
		FC= Compressor and fans OFF; CP=Compressor OFF; Fn=Fans OFF	-
dL	Switch between light and defog	0=light; 1~99: defog time	-

直冷式控制器

Direct-cooling type controller

LW2130/3000



制冷
Cooling



灯光
Light



除霜
Defrost



库温探头
Room temp



电源控制
Standby



扩展显示
Ext-display



数据笔
DLOAD



测量单位
°C/°F

LW2130



LW3000



产品型号信息 Model Info

产品系列 Model	软件型号 Software	压机1继电器 Comp. relay1	压机2继电器 Comp. relay2	端子规格 Terminal	电网电压 Supply	主板型号 Mainboard	继电器 Relay			蜂鸣音 Buzzer	内部标识 Mark	传感器 Sensor		显示颜色 Display Color	防爆 Explosion-proof
							R1	R2	R3			S1	S2		
LW2130	null N1...N99	H=2HP M=1HP	H=2HP M=1HP	V=NV Bar connect	null=AC220...240 A=AC100...127 W=AC100~240 D=DC7...60	20=LW3K-P20 21=LW3K-P21 30=LW3K-P30 31=LW3K-P31	COMP.	/	/	B	E	RT	/	G=绿色 W=白色	EX
LW3000	null=stand Nxx...	L<=10A res.	L<=10A res.				Comp1	Comp2	Light1			ET			

例: LW2130-MV-R1-S1-EX, M=1HP COMPRESSOR, V=NV Bar connect, R1=compressor relay, S1=room probe, EX=explosion-proof.

注: 上表仅为典型硬件配置, 如需了解详细情况, 请与我司联系. Note: The table only lists the typical hardware configuration. For more details, please contact us.

技术参数 Technical Parameters

额定电压: 220~240VAC, 短时最大过载电压 <264VAC/15min;

额定电压: 100~127VAC, 短时最大过载电压 <144VAC/15min

Rated voltage: 220~240VAC, Maximum overload voltage <264VAC/15min;

Rated voltage: 100~127VAC, Maximum overload voltage <144VAC/15min

整机功耗Consumption: ≤3W

测量范围Display range: -50°C~99°C/°F

控温范围Control range: -50°C~99°C/°F

测温精度Accuracy: -40°C~70°C, ±1°C; others, ±2°C

分辨率Resolution: 1

产品尺寸Dimensions(mm): 130×43×37(深Depth)/147×42×48(深Depth)

安装尺寸Mounting(mm): 112×39/138×32.5

接线图 Wiring diagrams

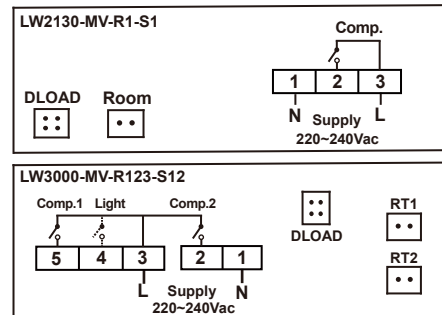

注: 更多接线图请翻阅详情表格.

Note: Please refer to the detailed table for more wiring diagrams.

参数表 Menu Parameters For Other version, please contact us.

LW-2130		
Description	Setting Range	Unit
User Menu		
St Temperature set point	C4...C5	°C
Management Menu		
PA Management password	0...99, master key=55	/
C1 Differential	1.0...10.0°C / 2...18°F	°C
C2 Compressor start minimum interval	0...99	min
C3 Room probe calibration	-5.0...5.0°C / -9...9°F	°C
C4 Minimum SetPoint	-50°C...St / -58°F...St	°C
C5 Maximum SetPoint	St...50°C / St...122°F	°C
C6 Compressor initial start minimum interval	0...99	sec
d2 Defrost cycle	0...99, 0=Defrost forbidden	hr
d3 Maximum defrosting time	1...99	min
d4 Display lock during defrost	0=room temperature; 1=dF; 2=temperature when defrost starts	/
d5 Room temperature display delay after defrost	0...99	min
A1 Cooling proportional off time when probe fails	0...99	min
A2 Cooling proportional on time when probe fails	0...99, 0=continuously off	min
A9 Display delay of 1°C/°F increasing	0...99	sec
LC Room temperature set point lock	0=lock; 1=unlock	/
P1 Set manager menu password	0...99, 0=not password	/
P4 Cooling and heating options	C=cooling; H=heating	/
P8 Temperature display	0=room temperature; 1=temperature set point	/
P9 °C/°F selection	°C=0.1°C; °F=1°F	/

速冻冰箱温度控制器

Standard temperature controller with quick freezing mode

ADC4300



支持插针传感器
support insert probe



产品型号信息 Model Info

产品系列 Model	软件型号 Software	压机继电器 Comp. relay	端子型号 Terminal	电网电压 Supply	主板型号 Mainboard	继电器 Relay			蜂鸣音 Buzzer	内部标识 Mark	传感器 Sensor				塑料壳 Plastic shell	防爆 Explosion-proof
						R1	R2	R3			S1	S2	S3	S4		
ADC4300	null N1...N99	H=2HP M=1HP L<=10A res.	T=Screw terminal V=NV Bar connect R=Plug terminal F=Tab terminal	null=AC220...240 A=AC100...127 W=AC100~240 D=DC8...60	31=AB-P31 35=AB-P35 37=AB-P37	Comp.	DEF	FAN	B	E	RT	ET	DT	PT	BK3	EX

例: ADC4300-MT31-R123-S1234-EX, M=1HP COMPRESSOR, T=Screw terminal, 31=PCB model, R1=compressor relay, R2=defrost relay, R3=fan relay, S1=room probe, S2=defrost probe, S3=Dig probe, S4=Insert Probe, EX=explosion-proof.

注: 上表仅为典型硬件配置, 如需了解详细情况, 请与我司联系. Note: The table only lists the typical hardware configuration. For more details, please contact us.

技术参数 Technical Parameters

额定电压: 220~240VAC, 短时最大过载电压 <264VAC/15min;
 额定电压: 100~127VAC, 短时最大过载电压 <144VAC/15min
 Rated voltage: 220~240VAC, Maximum overload voltage <264VAC/15min;
 Rated voltage: 100~127VAC, Maximum overload voltage <144VAC/15min
 整机功耗 Consumption: ≤3W
 测量范围 Display range: -50°C~99.9°C/199°F
 控温范围 Control range: -50°C~99.9°C/°F
 测温精度 Accuracy: -40~70°C, ≤±1°C; others, ≤±2°C
 分辨率 Resolution: -50~99.9°C/°F, 0.1; others, 1

接线图 Wiring diagrams

产品尺寸 Dimensions(mm): 76.5×35, 深度 Depth = 60
 安装尺寸 Mounting(mm): 71×29

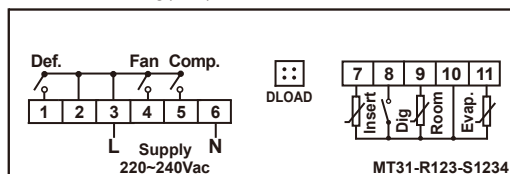

注: 更多接线图请翻阅详情表格.
 Note: Please refer to the detailed table for more wiring diagrams.

参数表 Menu Parameters For Other version, please contact us.

Description	Setting Range	Unit
Cyn	Cy1-Cy4; HLD=continue	/
PA	Management password	0...250;55=universal
Hy	Control differential	0.1...30.0 °C/°F
AC	Minimum compressor start interval	0...99 min
od	Compressor first start interval	0...99 min
t10	Cy1 mode force cooling Set point	-50.0...99.9 °C/°F
t11	Cy1 mode soft freezing Set point	-50.0...99.9 °C/°F
t12	Cy1 mode quick freezing Set point	-50.0...99.9 °C/°F
i10	Cy1 mode plug in probe force cooling Set point	-50.0...99.9 °C/°F
i11	Cy1 mode plug in probe soft freezing Set point	-50.0...99.9 °C/°F
i12	Cy1 mode plug in probe quick freezing Set point	-50.0...99.9 °C/°F
P10	Cy1 mode force cooling maximum working time	0...600 min
P11	Cy1 mode soft freezing maximum working time	0...600 min
P12	Cy1 mode quick freezing maximum working time	0...600 min
Hd1	Cy1 mode maintain process Set point	-50.0...99.9 °C/°F
t20	Cy2 mode force cooling Set point	-50.0...99.9 °C/°F
t21	Cy2 mode soft freezing Set point	-50.0...99.9 °C/°F
t22	Cy2 mode quick freezing Set point	-50.0...99.9 °C/°F
i20	Cy2 mode plug in probe force cooling Set point	-50.0...99.9 °C/°F
i21	Cy2 mode plug in probe soft freezing Set point	-50.0...99.9 °C/°F
i22	Cy2 mode plug in probe quick freezing Set point	-50.0...99.9 °C/°F
P20	Cy2 mode force cooling maximum working time	0...600 min
P21	Cy2 mode soft freezing maximum working time	0...600 min
P22	Cy2 mode quick freezing maximum working time	0...600 min
Hd2	Cy2 mode maintain process Set point	-50.0...99.9 °C/°F
t30	Cy3 mode force cooling Set point	-50.0...99.9 °C/°F
t31	Cy3 mode soft freezing Set point	-50.0...99.9 °C/°F
t32	Cy3 mode quick freezing Set point	-50.0...99.9 °C/°F
i30	Cy3 mode plug in probe force cooling Set point	-50.0...99.9 °C/°F
i31	Cy3 mode plug in probe soft freezing Set point	-50.0...99.9 °C/°F
i32	Cy3 mode plug in probe quick freezing Set point	-50.0...99.9 °C/°F
P30	Cy3 mode force cooling maximum working time	0...600 min
P31	Cy3 mode soft freezing maximum working time	0...600 min
P32	Cy3 mode quick freezing maximum working time	0...600 min
Hd3	Cy3 mode maintain process Set point	-50.0...99.9 °C/°F
t40	Cy4 mode force cooling Set point	-50.0...99.9 °C/°F
t41	Cy4 mode soft freezing Set point	-50.0...99.9 °C/°F
t42	Cy4 mode quick freezing Set point	-50.0...99.9 °C/°F
i40	Cy4 mode plug in probe force cooling Set point	-50.0...99.9 °C/°F
i41	Cy4 mode plug in probe soft freezing Set point	-50.0...99.9 °C/°F
i42	Cy4 mode plug in probe quick freezing Set point	-50.0...99.9 °C/°F
P40	Cy4 mode force cooling maximum working time	0...600 min
P41	Cy4 mode soft freezing maximum working time	0...600 min
P42	Cy4 mode quick freezing maximum working time	0...600 min
Hd4	Cy4 mode maintain process Set point	-50.0...99.9 °C/°F
Hd5	HLD mode maintain process Set point	-50.0...99.9 °C/°F
Pd	Minimum running time after compressor start	1...99 min
PAU	Pause working time	1...999 min
rEd	External display panel setting	0=room probe; 1=plug in probe
P1	Present plug in probe	n=no; y=yes
CA1	Storage probe calibration	-20.0...20.0 °C/°F
CA2	Plug in probe calibration	-20.0...20.0 °C/°F
CA3	Defrost probe calibration	-20.0...20.0 °C/°F
td	Defrost method	EL=electric; in=hot gas
id	Defrost circle	0...99, 0=disable defrost
md	Maximum defrost time	1...99 min
dE	Defrost end temperature	-50.0...99.9 °C/°F
dt	Defrost dripping time	0...99 min
dbc	Enable defrost in force cooling, soft freezing, quick freezing mode	n=no;y=yes; /
dd	Defrost start output delay	0...99 min
dF	Defrost display lock	0=room temperature; 1=display dEF, display delay after defrost
dAd	Display delay after defrost	0...99 min
Fdt	Fan start delay after defrost	0...99 min
FC	Fan running mode	0=synchronize with cooling; 1=working until 2=keep working
FSt	Fan stop temperature	-50.0...99.9 °C/°F
Cn	Proportional cooling off time	0...99 min
Cy	Proportional cooling on time	0...99 min
iP	Door signal polarity	no=disable; CL=close valid; oP=open valid
di	Door open overtime alarm	0...99 min
dC	Off fan if open door	n=no; y=yes
Ad	Over temperature alarm	0...600 min
dA	First alarm delay after power on	0...600 min
AU	Alarm upper differential	0.1...50.0 °C/°F
AL	Alarm lower differential	0.1...50.0 °C/°F
PAS	Password set	0...250, 0=cancel password
EPP	Evaporator probe	n=no; y=yes
CF	°C/°F selection	F=°F; C=°C

速冻冰箱-分体式温度控制器

Split type temperature controller with quick freezing mode

LSKN400



可选择从机控制盒型号 Optional control box

主型号 Model	固件代码 Firmware	压机继电器 Comp. relay	端子规格 Terminal	电网电压 Supply	外部接口 Interface	主板型号 Mainboard	继电器 Relay					传感器 Sensor				防爆 Explosion-proof
							R1	R2	R3	R4	R5	S1	S2	S3	S4	
ThinkBoxN1	FW0012	H=2HP M=1HP L<=10A res.	V=NV connect F=Tab terminal	null=AC220...240 A=AC100...127 W=AC100~240 D=DC8...60	null=TTL X=RS485	S1=TB-P51	COMP.	DEF	FAN	Heater	AUX	RT	ET	DT	Insert	EX

注：上表仅为典型硬件配置，如需了解详细情况，请与我司联系。Note: The table only lists the typical hardware configuration. For more details, please contact us.

技术参数 Technical Parameters

电源电压：4.5~5.5VDC, ThinkBoxN1-FW0012控制盒提供
Power Supply: 4.5~5.5VDC, ThinkBoxN1-FW0012 Control Box supply
整机功耗Consumption: ≤5W
测量范围Display range: -50°C~99.9°C/199°F
控温范围Control range: -50°C~99.9°C/°F
测温精度Accuracy: -40~70°C, ±1°C; others, ±2°C
分辨率Resolution: -50~99.9°C/°F, 0.1; others, 1
★需ThinkBoxN1控制盒配合使用, LSKN400为主机, 控制盒为从机
★ThinkBoxN1 control box is required, LSKN400 works as the host, and the control box works as the slave.
产品尺寸Dimensions(mm): 180×32×18.8(深Depth)
安装尺寸Mounting(mm): 173×26

接线图 Wiring diagrams

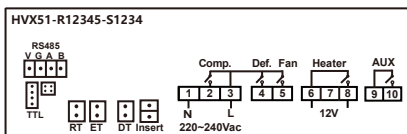

注：更多接线图请翻阅详情表格。
Note: Please refer to the detailed table for more wiring diagrams.

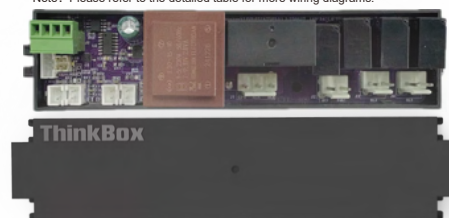

参数表 Menu Parameters For Other version, please contact us.

Menu	Description	Setting Range	Unit	i41	Cy4 mode insert probe soft freezing setpoint	-50.0..99.9	°C/°F
Cyn	Cooling mode start	Cy1-Cy4:HLD=continue	/	i42	Cy4 mode insert probe quick freezing setpoint	-50.0..99.9	°C/°F
PA	Management password	0..250:55=universal	/	P40	Cy4 mode force cooling maximum work time	0..600	min
Hy	Control differential	0.1..30.0	°C/°F	P41	Cy4 mode soft freezing maximum work time	0..600	min
AC	Minimum compressor start interval	0..99	min	P42	Cy4 mode quick freezing maximum work time	0..600	min
od	Compressor first start interval	0..99	min	Hd4	Cy4 mode maintain process setpoint	-50.0..99.9	°C/°F
t10	Cy1 mode force cooling setpoint	-50.0..99.9	°C/°F	P4	Cy4 mode enable insert probe	n=no,y=yes	/
t11	Cy1 mode soft freezing setpoint	-50.0..99.9	°C/°F	Hd5	Hold mode maintain process setpoint	-50.0..99.9	°C/°F
t12	Cy1 mode quick freezing setpoint	-50.0..99.9	°C/°F	P5	Hold mode enable insert probe	n=no,y=yes	/
i10	Cy1 mode insert probe force cooling setpoint	-50.0..99.9	°C/°F	Pd	Minimum work time after compressor start	0..999	min
i11	Cy1 mode insert probe soft freezing setpoint	-50.0..99.9	°C/°F	PAU	Pause time	1..999	min
i12	Cy1 mode insert probe quick freezing setpoint	-50.0..99.9	°C/°F	red	External panel, only MSKN400	0=room probe; 1= The remaining time; 2= Insert probe setpoint; 3= Insert probe	/
P10	Cy1 mode force cooling maximum work time	0..600	min	CA1	Room probe calibration	-20.0..20.0	°C/°F
P11	Cy1 mode soft freezing maximum work time	0..600	min	CA2	Insert probe calibration	-20.0..20.0	°C/°F
P12	Cy1 mode quick freezing maximum work time	0..600	min	CA3	Defrost probe calibration	-20.0..20.0	°C/°F
Hd1	Cy1 mode maintain process setpoint	-50.0..99.9	°C/°F	td	Defrost type	EL=electric; in=hot gas	/
P1	Cy1 mode enable insert probe	n=no,y=yes	/	id	Defrost circle	0..99, 0=disable defrost	hr
t20	Cy2 mode force cooling setpoint	-50.0..99.9	°C/°F	md	Maximum defrost time	1..99	min
t21	Cy2 mode soft freezing setpoint	-50.0..99.9	°C/°F	dE	Defrost end temperature	0..99.9	°C/°F
t22	Cy2 mode quick freezing setpoint	-50.0..99.9	°C/°F	dt	Drip time	0..99	min
i20	Cy2 mode insert probe force cooling setpoint	-50.0..99.9	°C/°F	dbc	Enable defrost in blast freezer process	n=no,y=yes;	/
i21	Cy2 mode insert probe soft freezing setpoint	-50.0..99.9	°C/°F	dd	Output delay after defrost start	0..99	min
i22	Cy2 mode insert probe quick freezing setpoint	-50.0..99.9	°C/°F	df	Display during defrosting	0=room probe; 1=dEF.delay after defrost	/
P20	Cy2 mode force cooling maximum work time	0..600	min	dAd	Display delay after defrost off	0..99	min
P21	Cy2 mode soft freezing maximum work time	0..600	min	Fdt	Fan start delay after defrost off	0..99	min
P22	Cy2 mode quick freezing maximum work time	0..600	min	FC	Fan work mode	0=synchronize with cooling;	/
Hd2	Cy2 mode maintain process setpoint	-50.0..99.9	°C/°F	FSt	Fan stop temperature	-50.0..99.9	°C/°F
P2	Cy2 mode enable insert probe	n=no,y=yes	/	Cn	Proportional cooling off time	0..99	min
t30	Cy3 mode force cooling setpoint	-50.0..99.9	°C/°F	Cy	Proportional cooling on time	0..99	min
t31	Cy3 mode soft freezing setpoint	-50.0..99.9	°C/°F	iP	Door signal polarity	no=disable; CL=close valid; oP=open valid	/
t32	Cy3 mode quick freezing setpoint	-50.0..99.9	°C/°F	di	Door open overtime alarm	0..99	min
i30	Cy3 mode insert probe force cooling setpoint	-50.0..99.9	°C/°F	dC	Off fan if open door	n=no,y=yes	/
i31	Cy3 mode insert probe soft freezing setpoint	-50.0..99.9	°C/°F	Ad	alarm delay if over temperature	0..999, 999=disable	min
i32	Cy3 mode insert probe quick freezing setpoint	-50.0..99.9	°C/°F	dA	First alarm delay after power on	0..600	min
P30	Cy3 mode force cooling maximum work time	0..600	min	AU	Alarm upper differential	0.1..50.0	°C/°F
P31	Cy3 mode soft freezing maximum work time	0..600	min	AL	Alarm lower differential	0.1..50.0	°C/°F
P32	Cy3 mode quick freezing maximum work time	0..600	min	PAS	Password set	0..250, 0=cancel password	/
Hd3	Cy3 mode maintain process setpoint	-50.0..99.9	°C/°F	EPP	Defrost probe enable	n=disable, y=enable	/
P3	Cy3 mode enable insert probe	n=no,y=yes	/	Pdt	Max temperature when insert probe for	-50.0..99.9	°C/°F
t40	Cy4 mode force cooling setpoint	-50.0..99.9	°C/°F	Pdd	Insert probe probe heating time	0..999, 0=disable probe heating	sec
t41	Cy4 mode soft freezing setpoint	-50.0..99.9	°C/°F	OA1	AUX relay config	0=light follow door state, 1=alarm output	/
t42	Cy4 mode quick freezing setpoint	-50.0..99.9	°C/°F	CF	°C/°F selection	F=°F; C=°C	/
i40	Cy4 mode insert probe force cooling setpoint	-50.0..99.9	°C/°F				

KeepThink

创新，源于持续的思考和行动

速冻冰箱-分体式温度控制器 Split type temperature controller with quick freezing mode

MSKN400



制冷
Cooling



除霜
Defrost



风机
Fan



灯光
Light



测量单位
°C/°F



速冻模式
Quick-freezing



探头≤4
Probe≤4



数据笔
DLOAD



调节0.1
Adjust 0.1



探头加热
Heatable probe

可选择从机控制盒型号 Optional control box

主型号	固件代码	压机继电器	端子规格	电网电压	外部接口	主板型号	继电器					传感器				防爆
Model	Firmware	Comp. relay	Terminal	Supply	Interface	Mainboard	R1	R2	R3	R4	R5	S1	S2	S3	S4	Explosion-proof
ThinkBoxN1	FW0012	H=2HP M=1HP L<=10A res.	V=NV connect F=Tab terminal	null=AC220...240 A=AC100...127 W=AC100~240 D=DC8...60	null=TTL X=RS485	S1=TB-P51	COMP.	DEF	FAN	Heater	AUX	RT	ET	DT	Insert	EX

注：上表仅为典型硬件配置，如需了解详细情况，请与我司联系。Note: The table only lists the typical hardware configuration. For more details, please contact us.

技术参数 Technical Parameters

电源电压：4.5~5.5VDC, ThinkBoxN1-FW0012控制盒提供
Power Supply: 4.5~5.5VDC, ThinkBoxN1-FW0012 Control Box supply

整机功耗Consumption: ≤5W

测量范围Display range: -50°C~99.9°C/199°F

控温范围Control range: -50°C~99.9°C/°F

测温精度Accuracy: -40~70°C, ±1°C; others, ±2°C

分辨率Resolution: -50~99.9°C/°F, 0.1; others, 1

★需ThinkBoxN1控制盒配合使用, MSKN400为主机, 控制盒为从机
★ThinkBoxN1 control box is required, MSKN400 works as the host, and the control box works as the slave.

产品尺寸Dimensions(mm): 170×58×21(深Depth)

安装尺寸Mounting(mm): 162×50

接线图 Wiring diagrams

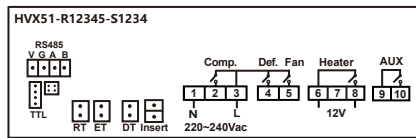

注：更多接线图请查阅详细表格。
Note: Please refer to the detailed table for more wiring diagrams.



参数表 Menu Parameters For Other version, please contact us.

Menu	Description	Setting Range	Unit
Cyn	Cooling mode start	Cy1-Cy4.HLD=continue	/
PA	Management password	0...250.55=universal	/
Hy	Control differential	0.1...30.0	°C/°F
AC	Minimum compressor start interval	0...99	min
od	Compressor first start interval	0...99	min
t10	Cy1 mode force cooling setpoint	-50.0...99.9	°C/°F
t11	Cy1 mode soft freezing setpoint	-50.0...99.9	°C/°F
t12	Cy1 mode quick freezing setpoint	-50.0...99.9	°C/°F
i10	Cy1 mode insert probe force cooling setpoint	-50.0...99.9	°C/°F
i11	Cy1 mode insert probe soft freezing setpoint	-50.0...99.9	°C/°F
i12	Cy1 mode insert probe quick freezing setpoint	-50.0...99.9	°C/°F
P10	Cy1 mode force cooling maximum work time	0...600	min
P11	Cy1 mode soft freezing maximum work time	0...600	min
P12	Cy1 mode quick freezing maximum work time	0...600	min
Hd1	Cy1 mode maintain process setpoint	-50.0...99.9	°C/°F
P1	Cy1 mode enable insert probe	n=no; y=yes	/
t20	Cy2 mode force cooling setpoint	-50.0...99.9	°C/°F
t21	Cy2 mode soft freezing setpoint	-50.0...99.9	°C/°F
t22	Cy2 mode quick freezing setpoint	-50.0...99.9	°C/°F
i20	Cy2 mode insert probe force cooling setpoint	-50.0...99.9	°C/°F
i21	Cy2 mode insert probe soft freezing setpoint	-50.0...99.9	°C/°F
i22	Cy2 mode insert probe quick freezing setpoint	-50.0...99.9	°C/°F
P20	Cy2 mode force cooling maximum work time	0...600	min
P21	Cy2 mode soft freezing maximum work time	0...600	min
P22	Cy2 mode quick freezing maximum work time	0...600	min
Hd2	Cy2 mode maintain process setpoint	-50.0...99.9	°C/°F
P2	Cy2 mode enable insert probe	n=no; y=yes	/
t30	Cy3 mode force cooling setpoint	-50.0...99.9	°C/°F
t31	Cy3 mode soft freezing setpoint	-50.0...99.9	°C/°F
t32	Cy3 mode quick freezing setpoint	-50.0...99.9	°C/°F
i30	Cy3 mode insert probe force cooling setpoint	-50.0...99.9	°C/°F
i31	Cy3 mode insert probe soft freezing setpoint	-50.0...99.9	°C/°F
i32	Cy3 mode insert probe quick freezing setpoint	-50.0...99.9	°C/°F
P30	Cy3 mode force cooling maximum work time	0...600	min
P31	Cy3 mode soft freezing maximum work time	0...600	min
P32	Cy3 mode quick freezing maximum work time	0...600	min
Hd3	Cy3 mode maintain process setpoint	-50.0...99.9	°C/°F
P3	Cy3 mode enable insert probe	n=no; y=yes	/
t40	Cy4 mode force cooling setpoint	-50.0...99.9	°C/°F
t41	Cy4 mode soft freezing setpoint	-50.0...99.9	°C/°F
t42	Cy4 mode quick freezing setpoint	-50.0...99.9	°C/°F
i40	Cy4 mode insert probe force cooling setpoint	-50.0...99.9	°C/°F

i41	Cy4 mode insert probe soft freezing setpoint	-50.0...99.9	°C/°F
i42	Cy4 mode insert probe quick freezing setpoint	-50.0...99.9	°C/°F
P40	Cy4 mode force cooling maximum work time	0...600	min
P41	Cy4 mode soft freezing maximum work time	0...600	min
P42	Cy4 mode quick freezing maximum work time	0...600	min
Hd4	Cy4 mode maintain process setpoint	-50.0...99.9	°C/°F
P4	Cy4 mode enable insert probe	n=no; y=yes	/
Hd5	Hold mode maintain process setpoint	-50.0...99.9	°C/°F
P5	Hold mode enable insert probe	n=no; y=yes	/
Pd	Minimum work time after compressor start	0...99	min
PAU	Pause time	1...999	min
rEd	External panel, only MSKN400	0=room probe; 1= The remaining time; 2= Insert probe setpoint; 3= Insert probe	/
CA1	Room probe calibration	-20.0...20.0	°C/°F
CA2	Insert probe calibration	-20.0...20.0	°C/°F
CA3	Defrost probe calibration	-20.0...20.0	°C/°F
td	Defrost type	EL=electric; in=hot gas	/
id	Defrost circle	0...99, 0=disable defrost	hr
md	Maximum defrost time	1...99	min
dE	Defrost end temperature	0...99.9	°C/°F
dt	Drip time	0...99	min
dbC	Enable defrost in blast freezer process	n=no; y=yes;	/
dd	Output delay after defrost start	0...99	min
dF	Display during defrosting	0=room probe; 1=dEF, delay after defrost	/
dAd	Display delay after defrost off	0...99	min
Fdt	Fan start delay after defrost off	0...99	min
FC	Fan work mode	0=synchronize with cooling;	/
FSt	Fan stop temperature	-50.0...99.9	°C/°F
Cn	Proportional cooling off time	0...99	min
Cy	Proportional cooling on time	0...99	min
iP	Door signal polarity	n=disable; CL=close valid; oP=open valid	/
di	Door open overtime alarm	0...99	min
dC	Off fan if open door	n=no; y=yes	/
Ad	alarm delay if over temperature	0...999, 999=disable	min
dA	First alarm delay after power on	0...600	min
AU	Alarm upper differential	0.1...50.0	°C/°F
AL	Alarm lower differential	0.1...50.0	°C/°F
PAS	Password set	0...250, 0=cancel password	/
EPP	Defrost probe enable	n=disable, y=enable	/
Pdt	Max temperature when insert probe for	-50.0...99.9	°C/°F
Pdd	Insert probe probe heating time	0...999, 0=disable probe heating	sec
OA1	AUX relay config	0=light follow door state, 1=alarm output	/
CF	°C/°F selection	F=°F; C=°C	/

ASKN系列-冷库控制器

ASKN series - Cold storage controller

ASKN100U/ASKN100X



可选择搭配控制盒型号信息 Optional control box

主型号	固件代码	压机继电器	端子规格	电网电压	外部接口	主板型号	继电器					传感器				防爆
Model	Firmware	Comp. relay	Terminal	Supply	Interface	Mainboard	R1	R2	R3	R4	R5	S1	S2	S3	S4	Explosion-proof
ThinkBoxN1	FWxxxx	H=2HP M=1HP L<=10A res.	V=NV connect F=Tab terminal	null=AC220...240 A=AC100...127 W=AC100~240 D=DC8...60	nul=TTL X=RS485	51=TB-P51	COMP.	DEF	FAN	LIGHT	DEFOG	RT	ET	DT	CT/PT	EX
						31=TB-P31	COMP.	DEF	FAN	/	/	RT	ET	DT	CT/PT	

注：上表仅为典型硬件配置，如需了解详细情况，请与我司联系。 Note: The table only lists the typical hardware configuration. For more details, please contact us.

技术参数 Technical Parameters

电源电压：4.5~5.5VDC/ThinkBoxN1-FW000F控制盒提供
Power Supply: 4.5~5.5VDC/ThinkBoxN1-FW000F Control Box supply
整机功耗 Consumption: ≤5W

测量范围 Display range: -50°C~99.9°C/199°F

控温范围 Control range: -50°C~99.9°C/F

测温精度 Accuracy: -40°C~70°C, ≤±1°C; others, ≤±2°C

分辨率 Resolution: -50~99.9°C/F, 0.1; others, 1

★需与ThinkBoxN1控制盒配合使用，ASKN100为主机，控制盒为从机

★ThinkBoxN1 control box is required, ASKN100 works as the host, and the control box works as the slave

产品尺寸 Dimensions: 76.5×35×33.7(深Depth)

安装尺寸 Mounting(mm): 71×29

接线图 Wiring diagrams

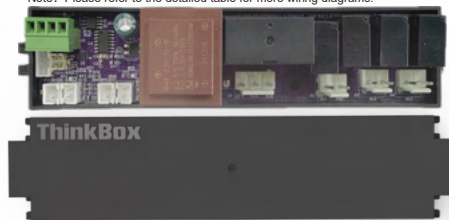
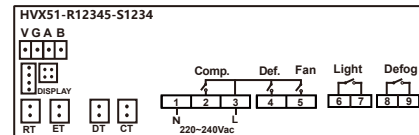

参数表 Menu Parameters For Other version, please contact us.

	Description	Range	Unit
User Menu			
St	Set point	C4...C5	°C/°F
Manager Menu			
PA	Manager menu password	0..99, master key=55	/
C1	Differential	0.1...50.0	°C/°F
C2	Compressor start Min. interval	0..99	min
C3	Room probe calibration	-20.0...20.0	°C/°F
C4	Minimum SetPoint	-50.0...St	°C/°F
C5	Maximum SetPoint	St...99.9	°C/°F
C6	Compressor initial start Min. interval	0..999	sec
d1	Defrost probe selection	0=disabled; 1=enable; 2=enable double defrost probe	/
d2	Interval between defrost cycle	0..99, 0=Defrost forbidden	hr
d3	Maximum length for defrost	1..99	min
d4	Display during defrost	0=real time temperature; 1=display 2=Room temperature when defrosts	/
d5	Room temperature display delay after defrost	0..99	min
d6	First defrosting interval after power on	10...999	min
d7	Defrost probe calibration	-20.0...20.0	°C/°F
d8	Defrost termination temperature	-50.0...99.9	°C/°F
d9	Dripping time after defrost	0..999	sec
d10	Defrost type	0=Electric; 1= Hot gas	/
d11	Defrost cycle calculation	0:cooling time; 1:natural time	/
d12	Time delay after defrost start	0..999,0=cancel defrost start delay	sec
d13	Defrost at power-on	0=off; 1=on;	/
F1	Fans operating mode	0=runs with the compressor, OFF during defrost; 1=continuous mode, OFF during defrost; 2=runs with the compressor, ON during defrost; 3=continuous	/
F2	Fans delay after defrost	0..99	min
F3	Fans stop temperature	-50.0...99.9	°C/°F
F4	Fan activation differential.	0.1...50.0	°C/°F
F5	Fans on time if cooling off	0..250, 0=cancel proportional running	sec
F6	Fans off time if cooling off	1..999	min
A1	Compressor proportional on time with faulty	0..99	min
A2	Compressor proportional off time with faulty probe	0..99, 0=off	min
A3	Temperature alarm delay	0..999, 999=disable	min
A4	Temperature alarm delay at startup	0..999	min
A5	Temp. alarm delay time after defrost	0..999	min
A6	Temperature alarm upper deviation	0.1...50.0	°C/°F
A7	Temperature alarm lower deviation	0.1...50.0	°C/°F
A8	Alarm exit deviation	0.1...20.0	°C/°F
A9	Display delay every 1°C/°F change	0..999	sec
L1	Digital input polarity	0=disable; 1=close valid; 2=open	/
L2	Digital signal valid,sound alarm	0=off; 1=on	/
L3	Digital signal valid,fan output	0=off; 1=no effect	/
L4	Digital signal valid,sound alarm start delay	0..999	sec
L5	Fan restart delay after door open	0..199	sec
L6	Digital signal valid,delay off cooling	0..999, 0=disable off cooling	min
L7	deep cool mode start deviation(not with ECO)	0.1...40.0	°C/°F
L8	deep cool mode stop deviation(not with ECO)	0.1...20.0	°C/°F
L9	deep cool mode start detection time	0..999, 0=disable deep cool mode	min
L10	deep cool mode maximum working time	0.1..99.9	hour
L11	Door action count for start defrost	0..199,0=disable to activate defrost	/
L12	Minimum cycle for door action to start defrost	1..999	min
L13	deep cool mode cycling continuous time	0..999	min
L14	deep cool mode cycling Setpoint	-50.0...99.9	°C/°F
L15	deep cool mode cycling control differential	0.1...20.0	°C/°F
CD1	Condenser cleaning period	0..250,0=cancel alarm	day
EC1	Enable ECO-DOOR mode	0=off; 1=on	/
EC2	Time to activate ECO mode	1..500	min
EC3	ECO mode differential	0.1...20.0	°C/°F
EC4	Time to activate store closing mode	1...500	min
EC5	Store closing mode differential	0.1...20.0	°C/°F
EC6	Number of actions to exit ECO mode	1...15	/
LC	Room temperature set point lock	0=lock; 1=unlock	/
P1	Set manager menu password	0..99, 0=cancel password	/
P5	Relay 2 load setting	0=Light; 1=defrost	/
P9	°C/°F selection	0=°F; 1=°C	/
Fg1	Interval between defog cycle	0..999, 0=Disable auto on defogging; 999=disable defog function	min
Fg2	Auto defog time	0..999, 0=Disable auto off defogging	min

有背景指示的触摸面板

Keepthink Touch Panel

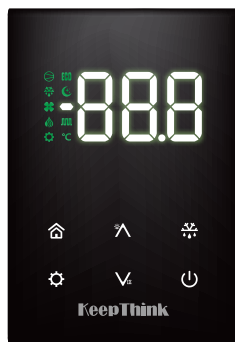

ESTN100V

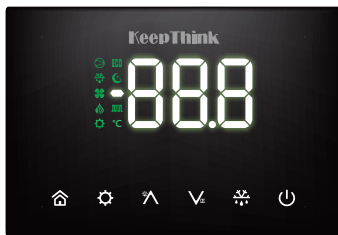

ESTN100H

ESTN系列 - 远程分体控制器

ESTN series - Remote split controller

ESTN100HU/ESTN100VU ESTN100HX/ESTN100VX



可选择搭配控制盒型号信息 Optional control box

主型号	固件代码	压机继电器	端子规格	电网电压	外部接口	主板型号	继电器					传感器				防爆
Model	Firmware	Comp. relay	Terminal	Supply	Interface	Mainboard	R1	R2	R3	R4	R5	S1	S2	S3	S4	Explosion-proof
ThinkBoxN1	FWxxxx	H=2HP M=1HP L<=10A res.	V=NV connect F=Tab terminal	null=AC220...240 A=AC100...127 W=AC100~240 D=DC8...60	nul=TTL X=RS485	51=TB-P51	COMP.	DEF	FAN	LIGHT	DEFOG	RT	ET	DT	CT/PT	EX
						31=TB-P31	COMP.	DEF	FAN	/	/	RT	ET	DT	CT/PT	

注：上表仅为典型硬件配置，如需了解详细情况，请与我司联系。Note: The table only lists the typical hardware configuration. For more details, please contact us.

技术参数 Technical Parameters

电源电压：4.5~5.5VDC/ThinkBoxN1-FW000F控制盒提供
Power Supply: 4.5~5.5VDC/ThinkBoxN1-FW000F Control Box supply
整机功耗Consumption: ≤5W
测量范围Display range: -50℃~99.9℃/199℉
控温范围Control range: -50℃~99.9℃/℉
测温精度Accuracy: -40℃~70℃, ±1℃; others, ±2℃
分辨率Resolution: -50~99.9℃/℉, 0.1; others, 1
★需与ThinkBoxN1控制盒配合使用, ESTN100为主机, 控制盒为从机
★ThinkBoxN1 control box is required, ESTN100 works as the host, and the control box works as the slave
产品尺寸Dimensions: 111.4×76.4×16.6+7.8(端子) (深Depth)
安装尺寸Mounting(mm): 108×73

接线图 Wiring diagrams

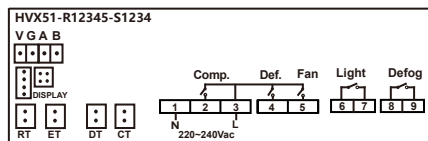

注：更多接线图请翻阅详情表格。
Note: Please refer to the detailed table for more wiring diagrams.

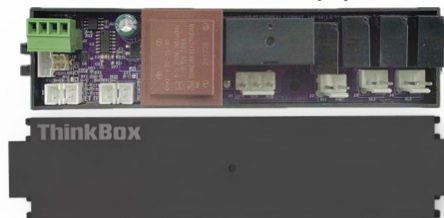

参数表 Menu Parameters For Other version, please contact us.

	Description	Range	Unit
User Menu			
St	Set point	C4...C5	℃/℉
Manager Menu			
PA	Manager menu password	0...99, master key=55	/
C1	Differential	0.1...50.0	℃/℉
C2	Compressor start Min. interval	0...99	min
C3	Room probe calibration	-20.0...20.0	℃/℉
C4	Minimum SetPoint	-50.0...St	℃/℉
C5	Maximum SetPoint	St...99.9	℃/℉
C6	Compressor initial start Min. interval	0...999	sec
d1	Defrost probe selection	0=disabled; 1=enable; 2=enable double defrost probe	/
d2	Interval between defrost cycle	0...99, 0=Defrost forbidden	hr
d3	Maximum length for defrost	1...99	min
d4	Display during defrost	0=real time temperature; 1=display 2=Room temperature when defrosts	/
d5	Room temperature display delay after defrost	0...99	min
d6	First defrosting interval after power on	10...999	min
d7	Defrost probe calibration	-20.0...20.0	℃/℉
d8	Defrost termination temperature	-50.0...99.9	℃/℉
d9	Dripping time after defrost	0...999	sec
d10	Defrost cycle type	0=Electric; 1= Hot gas	/
d11	Defrost cycle calculation	0: cooling time; 1: natural time	/
d12	Time delay after defrost start	0...999, 0=cancel defrost start delay	sec
d13	Defrost at power-on	0=off; 1=on;	/
F1	Fans operating mode	0=runs with the compressor, OFF during defrost; 1=continuous mode, OFF during defrost; 2=runs with the compressor, ON during defrost; 3=continuous	/
F2	Fans delay after defrost	0...99	min
F3	Fans stop temperature	-50.0...99.9	℃/℉
F4	Fan activation differential.	0.1...50.0	℃/℉
F5	Fans on time if cooling off	0...250, 0=cancel proportional running	sec
F6	Fans off time if cooling off	1...999	min
A1	Compressor proportional on time with faulty	0...99	min
A2	Compressor proportional off time with faulty probe	0...99, 0=off	min
A3	Temperature alarm delay	0...999, 999=disable	min
A4	Temperature alarm delay at startup	0...999	min
A5	Temp. alarm delay time after defrost	0...999	min
A6	Temperature alarm upper deviation	0.1...50.0	℃/℉
A7	Temperature alarm lower deviation	0.1...50.0	℃/℉
A8	Alarm exit deviation	0.1...20.0	℃/℉
A9	Display delay every 1℃/℉ change	0...999	sec
L1	Digital input polarity	0=disable; 1=close valid; 2=open	/
L2	Digital signal valid,sound alarm	0=off; 1=on	/
L3	Digital signal valid,fan output	0=off; 1=no effect	/
L4	Digital signal valid,sound alarm start delay	0...999	sec
L5	Fan restart delay after door open	0...199	sec
L6	Digital signal valid,delay off cooling	0...999, 0=disable off cooling	min
L7	deep cool mode start deviation(not with ECO)	0.1...40.0	℃/℉
L8	deep cool mode stop deviation(not with ECO)	0.1...20.0	℃/℉
L9	deep cool mode start detection time	0...999, 0=disable deep cool mode	min
L10	deep cool mode maximum working time	0...99.9	hour
L11	Door action count for start defrost	0...199, 0=disable to activate defrost	/
L12	Minimum cycle for door action to start defrost	1...999	min
L13	deep cool mode cycling continuous time	0...999	min
L14	deep cool mode cycling Setpoint	-50.0...99.9	℃/℉
L15	deep cool mode cycling control differential	0.1...20.0	℃/℉
Cd1	Condenser cleaning period	0...250, 0=cancel alarm	day
EC1	Enable ECO-DOOR mode	0=off; 1=on	/
EC2	Time to activate ECO mode	1...500	min
EC3	ECO mode differential	0.1...20.0	℃/℉
EC4	Time to activate store closing mode	1...500	min
EC5	Store closing mode differential	0.1...20.0	℃/℉
EC6	Number of actions to exit ECO mode	1...15	/
LC	Room temperature set point lock	0=lock; 1=unlock	/
P1	Set manager menu password	0...99, 0=cancel password	/
P5	Relay 2 load setting	0=Light; 1=defrost	/
P9	℃/℉ selection	0=℉; 1=℃	/
Fg1	Interval between defog cycle	0...999, 0=Disable auto on defogging; 999=disable defog function	min
Fg2	Auto defog time	0...999, 0=Disable auto off defogging	min

延时继电器

Time delay relay

DTR1



DTR2



应用说明 Application Description

适用于并联双电机的扩展驱动，错峰时间可定制；可提供防爆认证的继电器版本；

This is suitable for extended driving with two parallel electric motors, Scheduling can be customized to avoid peak times, Relay versions with explosion-proof certification are available.

技术参数 Technical Parameters

输入电压Input voltage: 180~240VAC, 50/60Hz;

输出能力Output capability: 30A/250VAC, 12FLA, 72LRA;

整机功耗Consumption: $\leq 3W$;

工作环境Work environment: $-10^{\circ}C \sim 55^{\circ}C$, 0%...90%RH、无凝露；

存储环境Storage Environment: $-25^{\circ}C \sim 75^{\circ}C$, 0%...90%RH、无凝露；

安装 Mounting

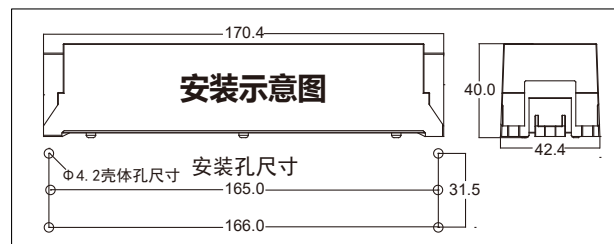

工作示意图 Work schematic diagram

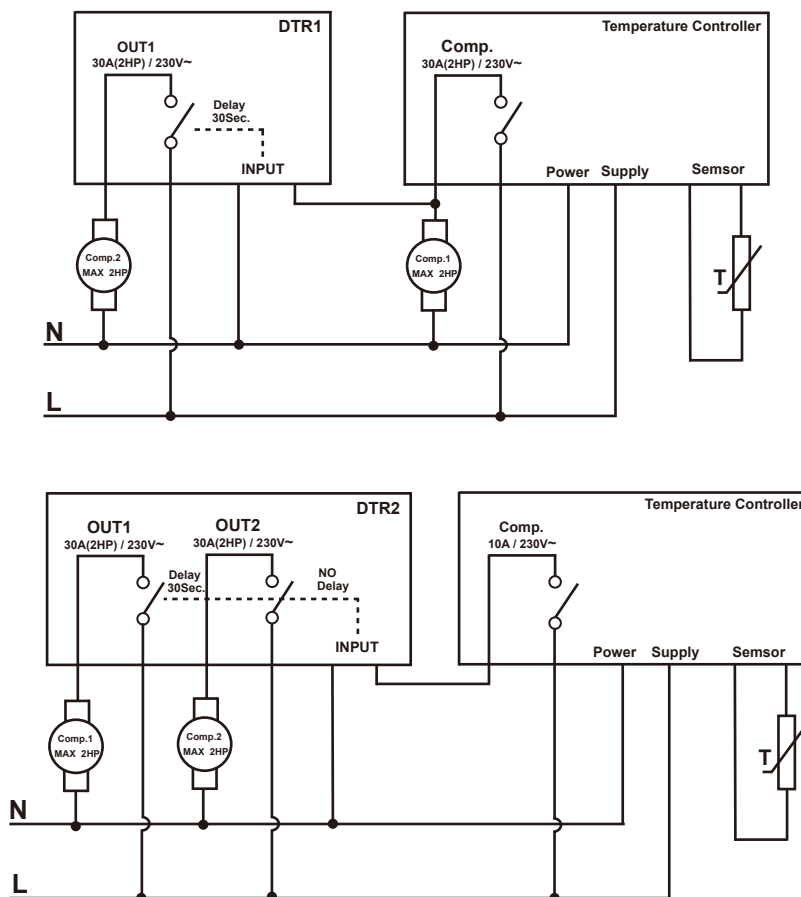



E37D1200:冰厚控制器 Ice Thickness Controller

E37D1200T:智能融霜控制器，可带温度保护探头
The intelligent frost melting controller can be equipped with a temperature protection probe.

应用说明 Application Description

E37D1200控制板可控制导电液体的灌装液位。

主要应用于：管道内流量指示器、高水位标志指示器、干运行保护、蓄冰装置蓄冰差控制器、冰厚控制器、冰库的压缩机开关。

The controller of the E37M120X series are able to control the filling level of electrically conductive liquids.

The possible applications: Flow indicator in Pipelines, High water mark Indicator

Dry Operation protection, Ice-Accretion difference controller in ice storage plants,

Ice-Accretion Controller, Compressor switching for ice banks.

技术参数 Technical Parameters

额定电压: 220~240VAC, 短时最大过载电压 < 264VAC/15min

Rated voltage: 220~240VAC, Maximum overload voltage < 264VAC/15min

整机功耗 Consumption: ≤ 2W

电极电压 Voltage at Electrodes: 约 10V~ appr. 10V~

电极间测量极限 Measured limits between electrodes: 水(Water) < 40KΩ, 冰或空气(Ice or Air) > 100KΩ

开关立即开启, 无延时 Switches immediately, no adjustable time delay.

环境温度 Ambient temperature: -20~60°C

环境湿度 Ambient humidity: 0%~80% (无结露 no condensation)

电气端子 Electrical connection: 螺钉式 Screws

线路板尺寸 Circuit board dimensions (mm): 73×49.5

接线图 Wiring diagrams

液面控制器 Level Controller

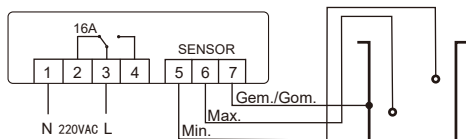

冰厚控制器 Ice-Accretion Controller

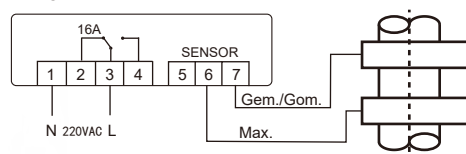

冰差控制器 Ice-Accretion Difference Control

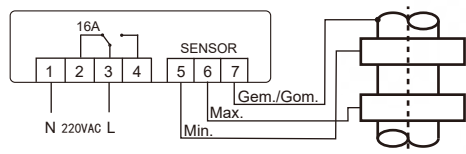

技术参数 Technical Parameters

稳态工作电流 (Max. Steady-state Current): 2A/25°C;

最大浪涌电流 (Max. Surge Current): 150A / 240VAC;

最短保护周期 (Min. Protect Period): 30sec;



浪涌抑制器

Surge suppressor

功能示意 Functional illustration

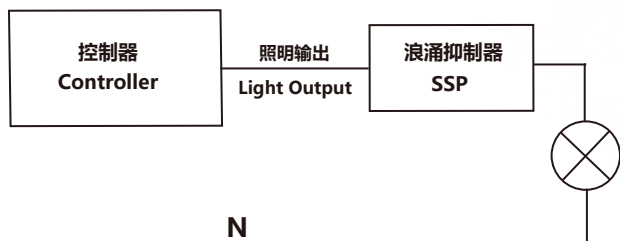

应用说明 Application Description

适用于LED灯电源的启动浪涌抑制，防止温控器灯光输出粘连；
Applicable to the suppression of start-up surges in LED lamp power supplies, Prevent the light output of the thermostat from becoming entangled.

DW-100

洗涤
Washing进水
Water-in清洗加热
Cleaning Heating漂洗加热
Rinse Heating探头≤6
Probes6数据笔
DLOAD门控
Gating

技术参数 Technical Parameters

额定电压: 220~240VAC, 短时最大过载电压<264VAC/15min

Rated voltage: 220~240VAC, Maximum overload voltage<264VAC/15min

整机功耗Consumption: ≤5W

测量范围Display range: 0°C~99.9°C

测温精度Accuracy: -40°C~70°C, ≤±1°C; others, ≤±2°C

分辨率Resolution: 0.1

电源板尺寸Power board dimensions(mm): 146×37

操作板尺寸Handle board dimensions (mm): 162×30

接线图 Wiring diagrams

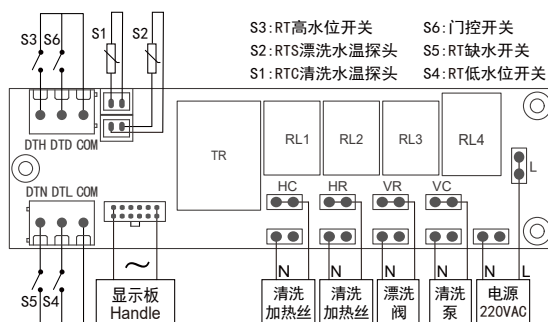

参数表 Menu Parameters For Other version, please contact us.

菜单	菜单描述	设定范围	单位
Std	档位选择	d1~d3	/
管理菜单			
PA	管理者菜单密码输入	0~99, 55=万能密码	/
C1	清洗温度设定值	0.0~99.9	°C
C2	漂洗温度设定值	0.0~99.9	°C
C3	清洗温度回差	1.0~30.0	°C
C4	漂洗温度回差	1.0~30.0	°C
C5	清洗温度探头校正	-10.0~10.0	°C
C6	漂洗温度探头校正	-10.0~10.0	°C
C7	清洗启动延时	0~30	sec
C8	缺水或低水位开关连续有效时长	1~30	sec
C9	档位1清洗时间	10~999	sec
C10	档位2清洗时间	10~999	sec
C11	档位3清洗时间	10~999	sec
C12	沥水时间	0~255	sec
C13	漂洗时间	1~255	sec
C14	进水温度回差	1.0~30.0	°C
P1	控制器密码	0~99	/

P系列-面板表 P series - Panel display

P700,P800/P850,P900,P1000/P1050



P1000/P1050 超大显示区域 Large display area

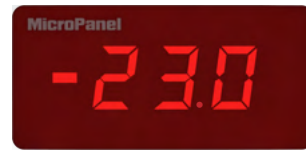

P900



P800/P850



P700

标准开孔尺寸 Mounting Size: 71*29(mm)

效果图等比缩放 The effect drawing is scaled equally

应用 Application

适用于蛋糕柜、冷藏柜、展示柜等需要精确测量温度的各种设备
Suitable for cake cabinets, freezers, display cabinets and other equipment needing temperature precise measurement.

功能特点 Functions

P1000/P900/P801/P700

独立式面板表 Freestanding panel table

一路温度传感器用于温度测量 A temperature sensor is used for temperature measurement

出厂时可设置测量单位°F/°C、温度校正值、显示分辨率 The unit of °F/°C, correction value and resolution can be set before leaving the factory

螺钉式电源接线, 插拔式温度双层防护探头 Screw type power connection, plug and pull type double-layer protective temperature probe

支持超宽工作电压范围, 低功耗设计 Support ultra wide operating voltage range, low power consumption design

P1050/P950/P850

配合控制器, 整体使用 Work with the controller for overall use

实时同步显示控制器测量温度 Real-time synchronous display controller measurement temperature

产品型号信息 Model Info

产品系列 Model	显示颜色 Display Color	电网电压 Supply	温度单位 Unit	温度校正 Correct	显示分辨率 Resolution
P700	R=red W=white G=green B=blue	nul=220Vac Isolated Power A1=110Vac Isolated Power	C=celsius F=Fahrenheit	N5-N1,Z,P1-P5	X=decimal Y=integer
P800		A=60~264Vac			
P900		D1=10~15Vdc			
P1000		D2=8~60Vdc			
P850 P1050		follow master			

例: P1000G-ACZX, G=green Display Color, A=60-264Vac Supply, C=celsius Unit, Z=Z Correct, X=decimal Resolution.

注: 上表仅为典型硬件配置, 如需了解详细情况, 请与我司联系.

安装尺寸 Product size

model	Installation	Plastic shell size
P700	L=71.0, W=29.0	L=76.5, W=35.5, D=44
P801	L=65.5, W=19.0	L=83.2, W=23.6, D=35.0
P850	L=65.5, W=19.0	L=83.2, W=23.6, D=18.0
P900, P901	L=58.4, W=25.7	L=63.8, W=30.5, D=33.5
P1000, P1050	L=99.0, W=48.0	L=109.0, W=54.0, D=28.0

DataLink/ DataLinkS RS485转换器

DataLink



DataLinkS



应用 Application

适用于需要数据传输及远程监控的各类设备，例如冷库、超市、便利店等场所，1000米范围内能可靠通信。

It is suitable for all kinds of equipment that need data transmission and remote monitoring, such as cold storage, supermarkets, convenience stores and other places, and can communicate reliably within a range of 1000 meters.

功能特点 Functions

经过优化的控制器协议，在远程实现监控设备工作状态的同时大幅减轻设备数量众多时的通信拥堵。

DataLinkX内部自带抗浪涌保护、抗骚扰电压反向冲击控制器电源电路。每个模块均内置电源指示灯和通信信号检查指示灯。

外型精致、灵巧，安装方便，接线灵活，允许使用网关构建分层网络。

The optimized controller protocol can greatly reduce the communication congestion when there are a large number of devices when remotely monitoring the working status of the devices. DataLinkX has built-in anti-surge protection, anti-disturbance voltage reverse impact controller power supply circuit. Each module has power indicator and communication signal indicator. Exquisite and smart appearance, easy installation, flexible wiring, allowing the use of gateways to build a layered network.

接线图 Connections

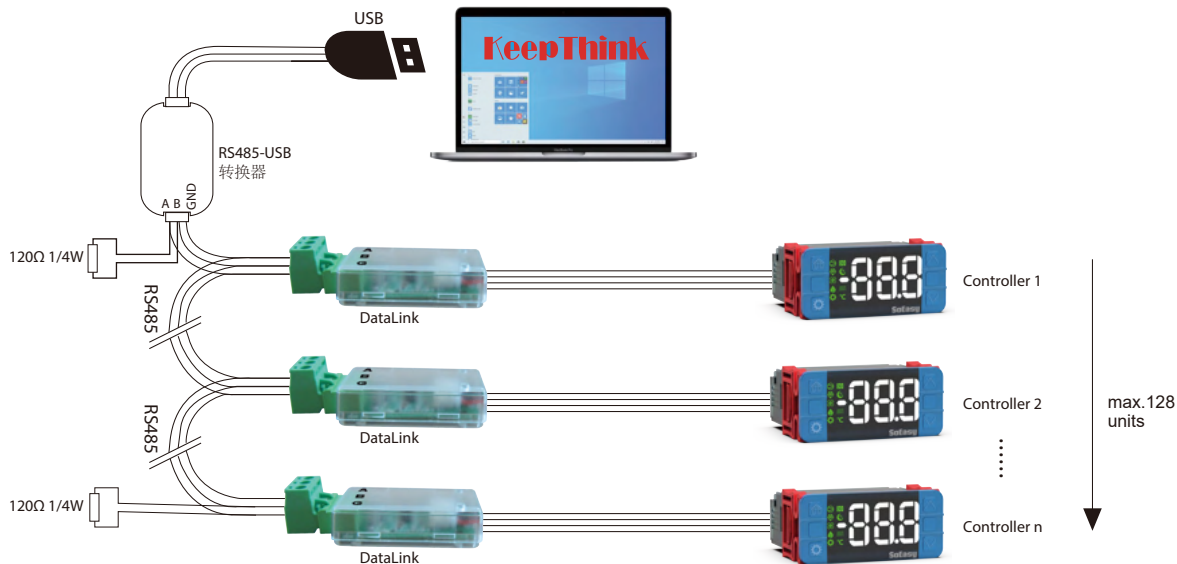

接线说明：将RS485-USB转换器和两个120Ω 1/4W电阻安装在第一台设备和最后一台设备。使用一根4芯线将DataLink-X与控制器单元连接。

建议采用带屏蔽的双绞线作为连接线，双绞线的横截面积为0.5-1.5mm²（AW 622-24类型）。最长允许接线长度为1000米。

Wiring Instructions: Install the RS485-USB converter and two 120Ω 1/4W resistors on the first device and the last device. Use a 4-conductor cable to connect the DataLink-X to the controller unit. It is recommended to use a shielded twisted pair as the connecting wire, and the cross-sectional area of the twisted pair is 0.5-1.5mm² (type AW 622-24). The longest allowable wiring length is 1000 meters.

DLOAD

应用 Application

用于控制器参数批量快速修改及管理 Used for fast batch modification and management of controller parameters

功能特点 Functions

使用方便灵活；可充电宝、充电器供电；具有防篡改保护开关 Easy and flexible, support powerbanks and chargers, with tamper-proof protection switch

方便厂商和经销商的产品生产和售后服务 Offer convenience for manufacturers and dealers in product production and after-sales service

对应控制器型号具有唯一识别码，可有效防止产品型号间参数误导入 The corresponding controller model has a unique identification code, which can effectively prevent misleading parameters between product model

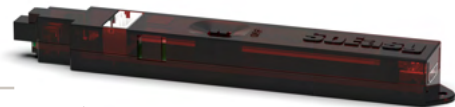

防水盒 Waterproof housing

应用 Application

配套SoEasy系列控制使用，防止蒸汽冷凝成水滴落和冷柜清洗时渗水造成的机器故障





Supporting SoEasy series controller is used to prevent leaking of steam condensing water and machine failure caused by water seepage during refrigerator cleaning.

功能特点 Functions

防水防蒸汽；更有效提高产品防护等级；安装方便 Water proof and steam proof, improve product protection level more effectively, easy to install.



探头 Sensor

Model	Sensor	Wire	Color	Shell	Length	Connect	Range	Note	Image	For example
KTS001	NTC	single TPE	Blue	5.2*6.2*15	50 ~ 9900mm	PH2/XH2...	-50 ~ 105°C	/		KTS001-200 KTS002-200-PH2 KTS003-200-XH2
KTS002	NTC	single TPE	Black							
KTS003	NTC	single TPE	Red							
KTS004	NTC	single TPE	Grey							
KTS006	NTC	double PVC	Black/White	7*25	50 ~ 9900mm	PH2/XH2...	-40 ~ 70°C	/		KTS006-200-XH2
KTS005	NTC	PTFE+Silicone	Black	6*40	50 ~ 9900mm	PH2/XH2...	-100 ~ 50°C	/		KTS005-200
KTS007	NTC	double PVC	Black/White	6*40	50 ~ 9900mm	PH2/XH2...	-50 ~ 105°C			KTS007-200
KTC010	PTC KTY81-121	Silicone	Black	6*40	50 ~ 500mm	PH2/XH2...	-55 ~ 150°C			KTC010-200
KTS011	NTC	Silicone	Black	6*40	50 ~ 500mm	PH2/XH2...	0 ~ 200°C			KTS011-200
KTS019	PT100	PTFE+Silicone	Black	6*40	50 ~ 350mm	PH2/XH2...	-70 ~ 50°C			KTS019-200
KTS020	PT1000	PTFE+Silicone	Black	6*40	50 ~ 350mm	PH2/XH2...	-200 ~ 30°C			KTS020-200
KTC008	NTC	double TPE	Black	5*125	100 ~ 1000mm	PH2/XH2...	-50 ~ 105°C	/		KTS008-350
KTS008H	NTC	double TPE	Black	5*125	100 ~ 1000mm	PH2/XH2...	-50 ~ 105°C	heating		KTS008H-350
KTC012	NTC	double TPE	Black	5.5*160	100 ~ 1000mm	PH2/XH2...	-50 ~ 105°C	/		KTS012-350
KTS012H	NTC	double TPE	Black	5.5*160	100 ~ 1000mm	PH2/XH2...	-50 ~ 105°C	heating		KTS012H-350
KTS013	3PCS NTC	double TPE	Black	5.5*160	100 ~ 1000mm	PH2/XH2...	-50 ~ 105°C	/		KTS013-350
KTSK	K TC	Metal	Black	/	50 ~ 9900mm	/	-200 ~ 1000°C	/	/	KTSK-200
KTSJ	J TC	Metal	Black	/	50 ~ 9900mm	/	-200 ~ 1000°C	/	/	KTSJ-200

磁性开关传感器(SS-2) Magnetic switching sensor (SS-2)

技术参数 Technical Parameters

初始接触电阻 Initial contact resistance: $\leq 150\text{m}\Omega$ (线缆除外 Cable not included)	绝缘电阻 Insulation resistance: 1000M Ω
切换电压 Switching voltage: $\leq 24\text{VDC}$	存储温度 Storage temperature: -25 ~ 85°C
切换电流 Switching current: $\leq 500\text{mA}$	震动 Shock: 20g 冲击 Impact: 30g
机械耐久性 Mechanical durability: 100 million Cycle	防水等级 IP level: IP67
电耐久性 Durability of electricity: 100,000 @100V, 100mA	工作环境温度 Operating temperature: -25 ~ 85°C
功能 Function:	感应距离 > 28mm

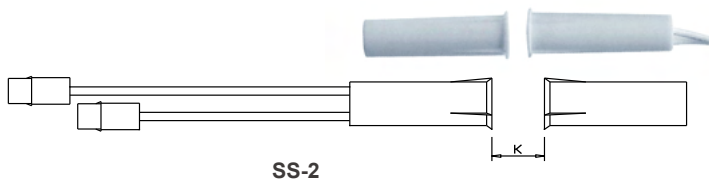

SS-2



KTS3515CH

湿度传感器 KTS3515CH Humidity Sensor (KTS3515CH)

技术参数 Technical Parameters

0~5VDC电压型输出, 耐腐蚀, 耐凝水, 初始精度3.5%RH, 年化漂移<2%RH。

Voltage signal output :0~5VDC;corrosion resistance, protection against condensate water,Initial accuracy3.5%RH,annual drift rate<2%RH.

AB-P10系列主板 AB-P10 series Mainboard

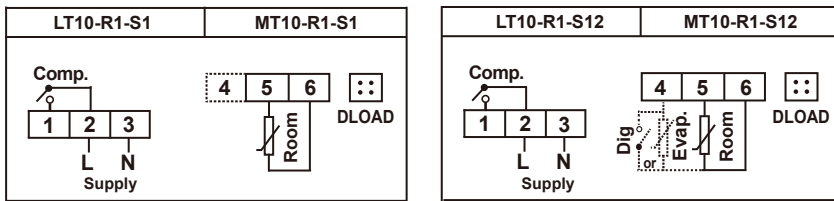

AB-P20系列主板 AB-P20 series Mainboard

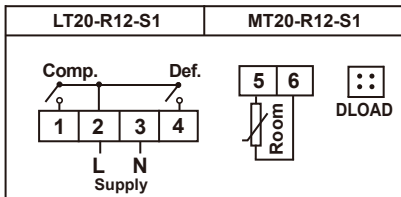

AB-P23系列主板 AB-P23 series Mainboard

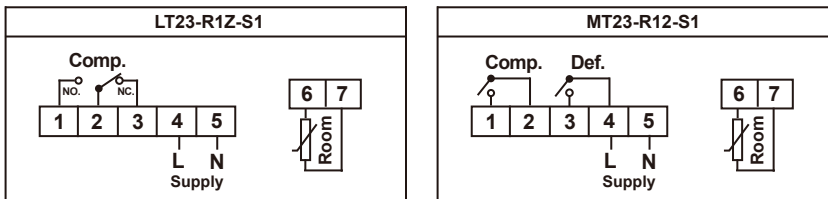

AB-P24系列主板 AB-P24 series Mainboard

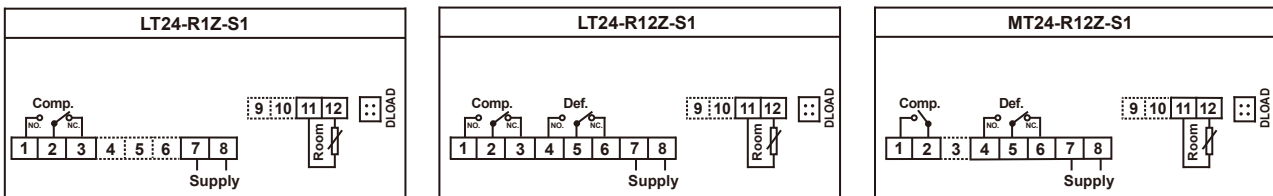

AB-P31系列主板 AB-P31 series Mainboard

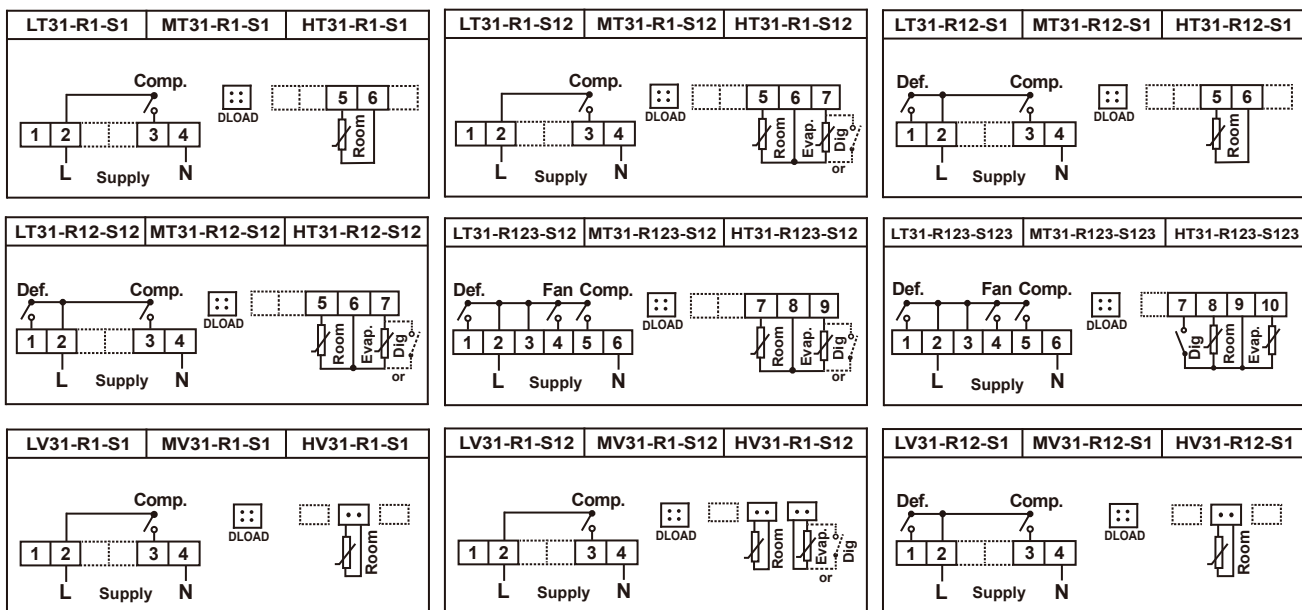

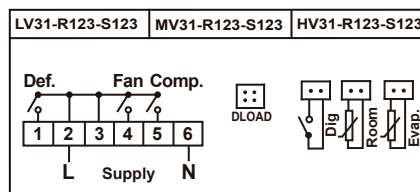
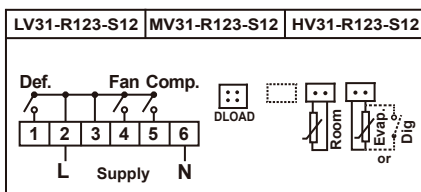
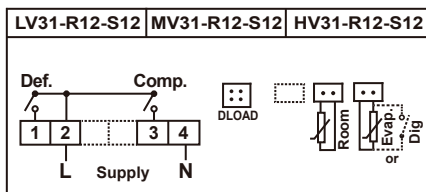

AB-P33系列主板 AB-P33 series Mainboard

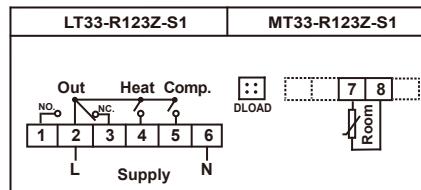
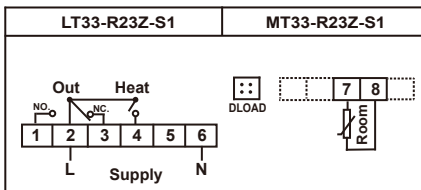

AB-P35系列主板 AB-P35 series Mainboard

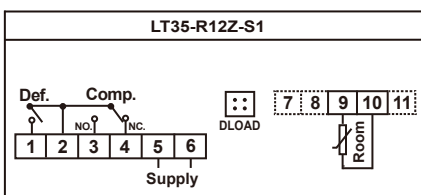
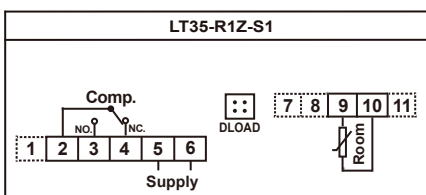

AB-P37系列主板 AB-P37 series Mainboard

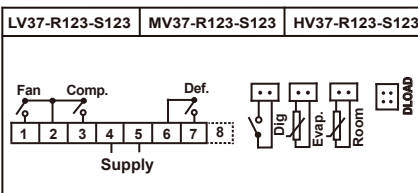
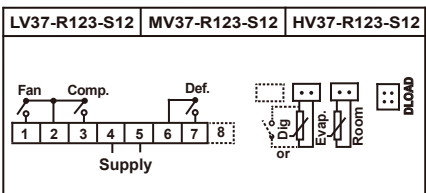
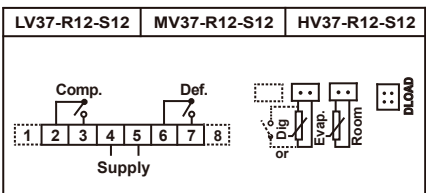
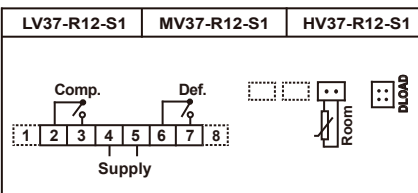
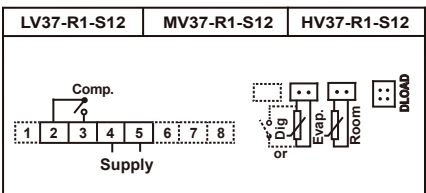
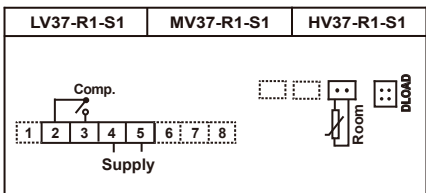
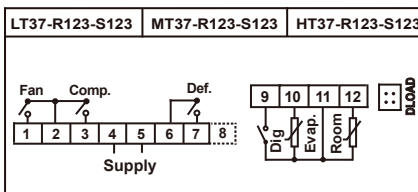
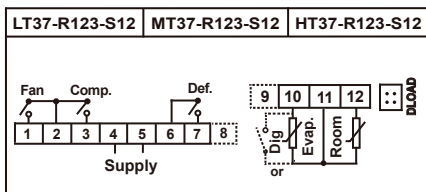
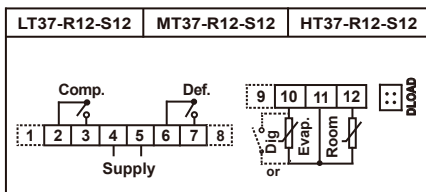
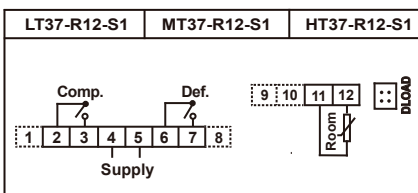
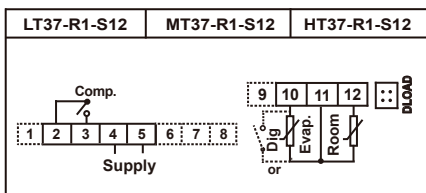
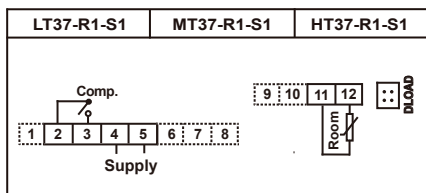

AB-P41系列主板 AB-P41 series Mainboard

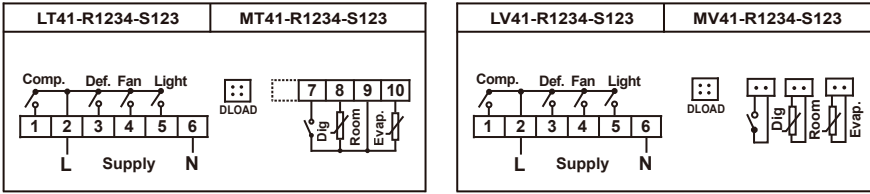

AB-P43系列主板 AB-P43 series Mainboard

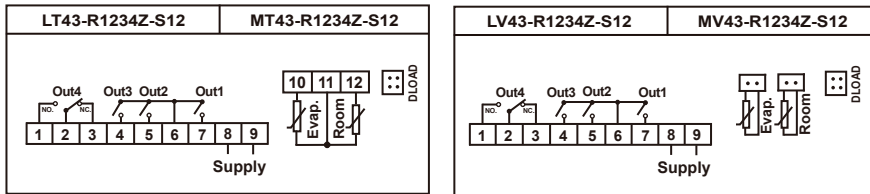

AB-P44系列主板 AB-P44 series Mainboard

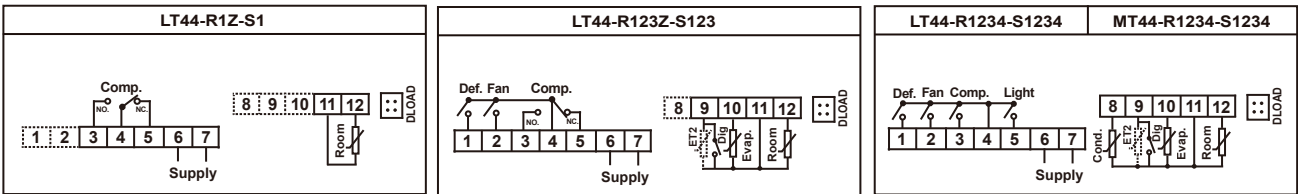

LW1000系列主板 LW1000 series Mainboard

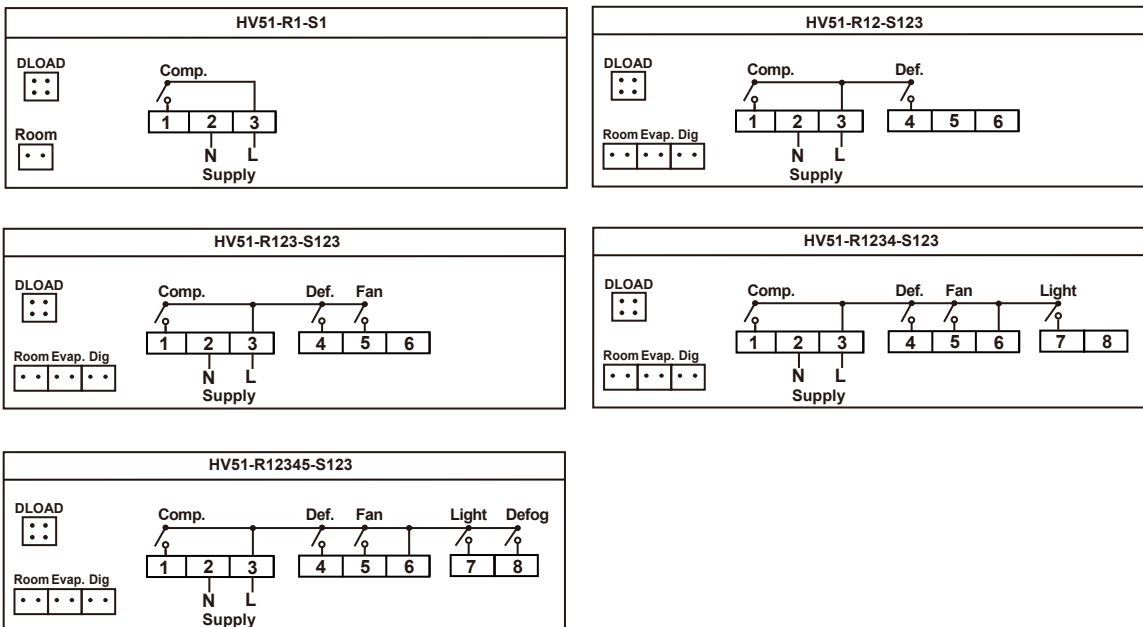

ThinkBoxN1系列主板 ThinkBoxN1 series Mainboard

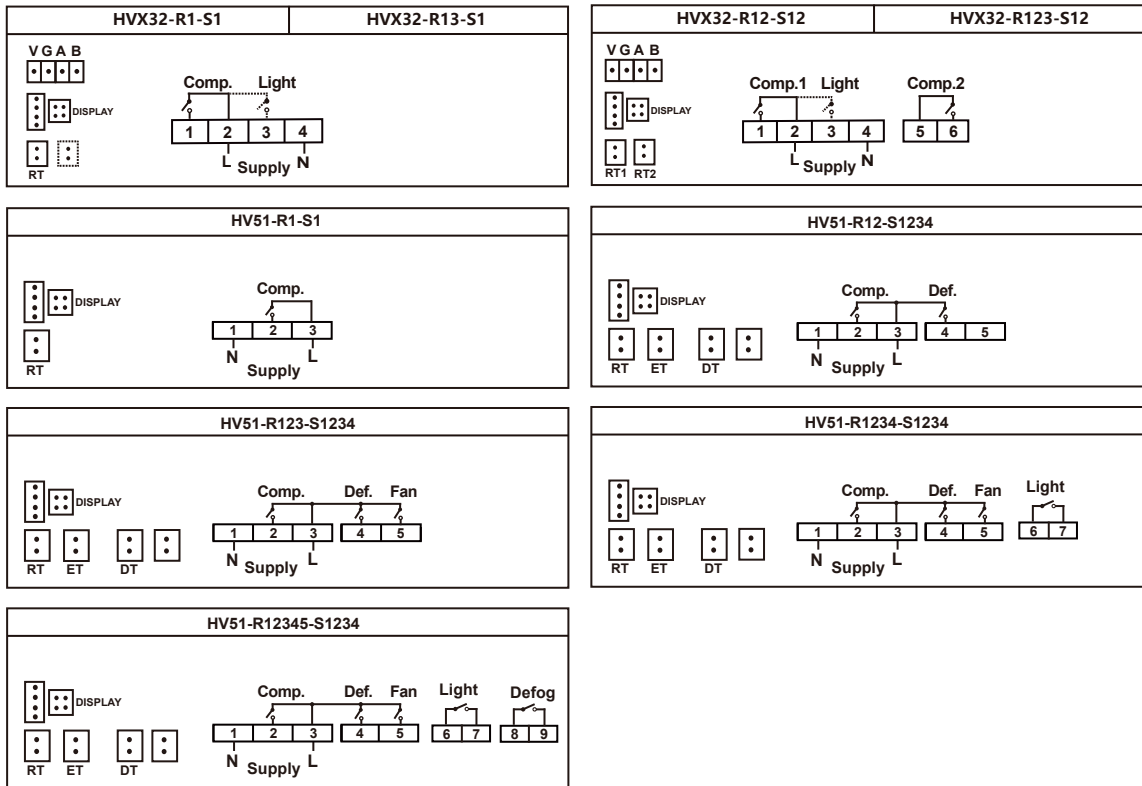

海外业务

Eric@keep-think.com

sam.x@keep-think.com

factory@keep-think.com

man.lee@keep-think.com

国内业务



CEO



frank.ye@keep-think.com

凯普信采用持续开发策略，因此保留在未事先通知的情况下对产品进行变更和改进的权利。

凯普信不承担任何因排版或印刷错漏而产生的责任，本资料中的各类描述随时可能变更，恕不事先通知。

如资料中的图片及文字与产品实物有不同之处，均以实物为准。

KeepThink adopts sustainable development strategy,

so we reserve the right to make changes and improvements to the product without prior notice.

KeepThink does not assume any responsibility for typesetting or printing errors.

Various descriptions in this information may be changed at any time without prior notice.

If there is any difference between the pictures , text and the actual products, the latter prevail.

江苏凯普信电气技术有限公司
KeepThink Electric Technology Co., Ltd.

2025年秋季版

2025 autumn edition